

# Polytegola N

Bitumen Roof shingles

## Application guide

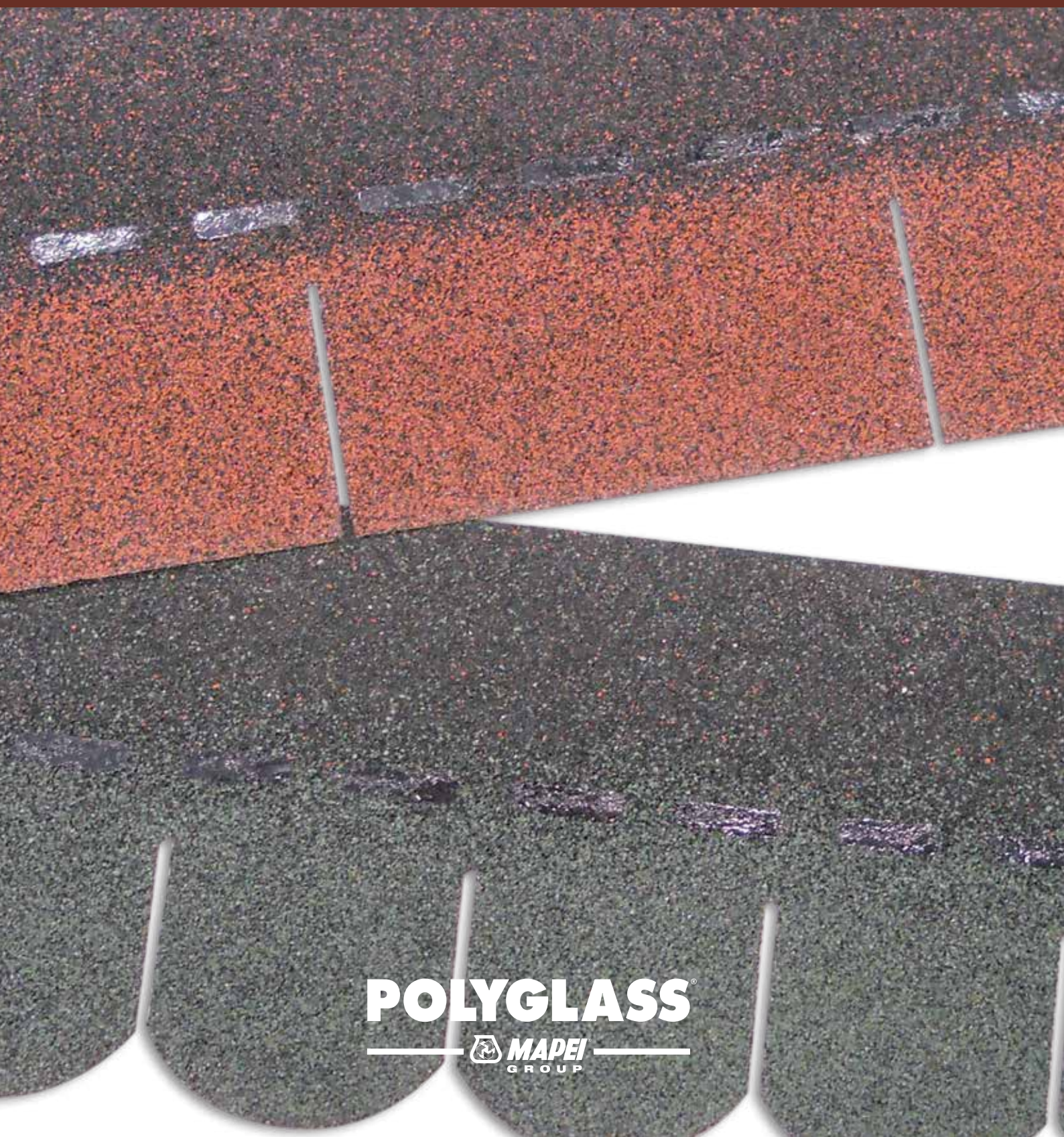

**POLYGLASS**<sup>®</sup>





# CONTENT

1. Foreword - General conditions	3
2. POLYTEGOLA N designs	4
3. Roof pitches	5
4. Storage	5
5. Roof decking	5
6. Ventilation	5
7. Underlay	6
8. Laying the shingles	6
9. Fixing the shingles	8
10. Eaves line	9
11. Ridge and hip line	10
12. Valleys	11
13. Roof edge	12
14. Chimney junction	14
15. Glossary	14





---

---

## 1. FOREWORD - GENERAL CONDITIONS

POLYTEGOLA N must be laid following the instructions given herein to achieve a satisfactory, functional and long-lasting end result.

Do not use more than one POLYTEGOLA N shingle design on any one roof surface.

Different shades of colour on the shingles are an inherent feature, not a defect. To minimize differences in colour, we recommend picking shingles from different packs at random. We also recommend that on any one roof surface, you apply shingles belonging to the same production batch (indicated on the label).

Do not remove the parting strip of tape from the back of the shingle: it is there for packaging purposes only and does not affect installation.

The factory-applied adhesive strips' bond will only be effective once they are exposed to heat or direct sunlight. In cold weather or on steep roofs, you will need to apply Polyseal bituminous sealant manually.

Shingles cannot be applied directly to a surface of thermal insulation; there must be an unbroken ventilation area between the top side of the insulation panels and the roof decking the shingles are attached to.

To prevent footprints or impressions forming, do not walk on shingles laid on the part of the roof exposed to the sun during the warmer months or when the sun is strong.

Shingles must be nailed on only; they cannot be "torched on", hot-welded or cold-glued.

Where you are directed to use Polyseal bituminous sealant, be careful to apply the correct amount and distribute it evenly without allowing it to build up excessively.

Polyglass SpA disclaims responsibility for issues resulting from incorrect and/or non-compliant application or preparation of the roof decking the shingles are laid on.



## 2. 2. POLYTEGOLA N DESIGNS

POLYTEGOLA N comes in **rectangular** 3-tab strips (figure 1) and in 6-tab **beaver tail** strips (figure 2).

### RECTANGULAR POLYTEGOLA N (figure 1)

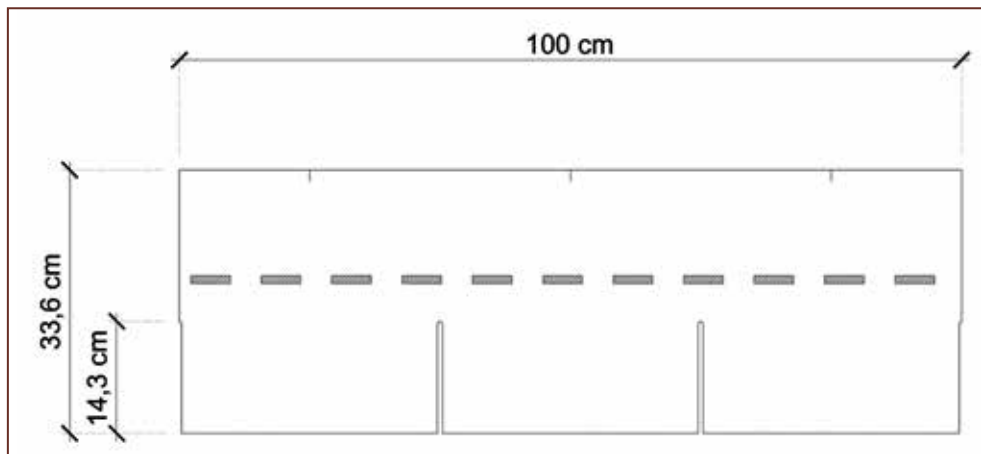

### BEAVER TAIL POLYTEGOLA N (figure 2)

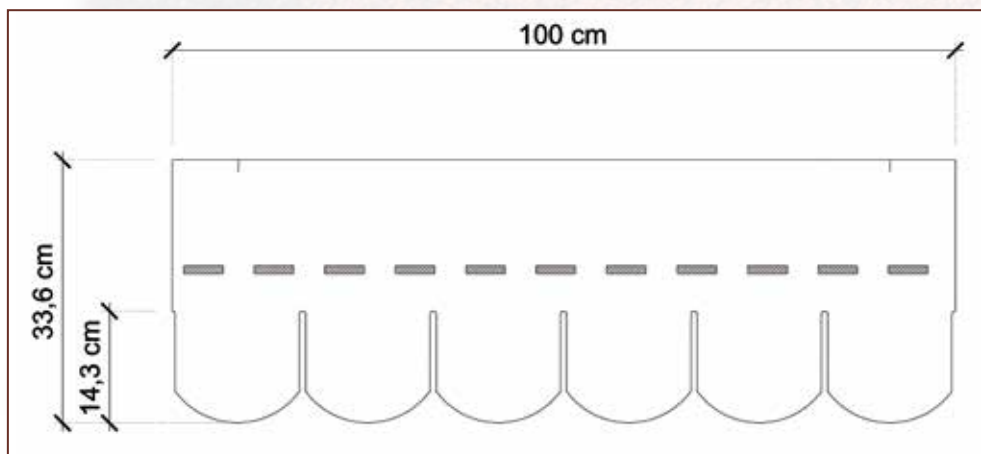



### 3. ROOF PITCHES

POLYTEGOLA N must be laid only on roofs with a suitable pitch, ranging from 15° to 85°.

Shingles must be suitably overlapped (refer to exposure values) as directed (see table below).

The shingles feature notches marking the 14.3 cm exposure level and other notches at right angles to be taken as references for offsetting.

POLYTEGOLA N type	Roof pitch	Exposure	Roof coverage per pack	kg m <sup>2</sup>
<b>RECTANGULAR</b>	15° - 25°	12,5 cm	2,62 m <sup>2</sup>	11,0
	26° - 85°	14,3 cm	3,00 m <sup>2</sup>	9,6
<b>BEAVER TAIL</b>	15° - 25°	12,5 cm	2,62 m <sup>2</sup>	10,5
	26° - 85°	14,3 cm	3,00 m <sup>2</sup>	9,2

### 4. STORAGE

Store the material appropriately in a dry place out of the elements. Do not leave it exposed to direct sunlight and do not store near heat sources. Do not stack pallets on top of each other.

POLYTEGOLA N maximum storage height: 18 packs.

### 5. ROOF DECKING

POLYTEGOLA N is applied by nailing it onto wooden roof decking. The deck must be flat, dimensionally stable, moisture proofed, suitably secured to the roof frame, dry and clean. Suitable decking materials include plywood and oriented strand boards (OSB). Wooden boards can be maximum 15 cm wide. The thickness of the deck depends on the span between the beams.

The deck must be thick enough to ensure the shingles can be nailed on properly using specific broad-headed (9-11 mm head) corrosion-resistant steel nails 20-25 mm long.

The quality and preparation of the deck are essential to the success and lengthy service life of the roof covering and so we urge you to always comply with the installation directions/rules given by the wooden decking suppliers.

### 6. VENTILATION

Heat and water vapour must be allowed to escape through the roofing by creating an effective and functional ventilation system.

To this end, air must be free to circulate all over the top side of the thermal insulation layer and the decking the shingles are supported by from the ridge to the eaves.

Also ventilate hips.

The ventilation system must be sized and produced to meet current technical standards and building code requirements.

In order to produce effective ridge and hip lines, we recommend using specific prefabricated ventilated ridges, such as POLYTEGOLA N Ridge Vent.



## 7. UNDERLAY

Polystick Tu Plus self-adhesive membrane must be applied on the roof deck. It must be applied parallel to the eaves line and must be mechanically fixed to the deck with broad-headed nails as illustrated in figure 3.

The underlay must be laid so that it is completely smooth without any creases or imperfections, as flat as possible against the deck to avoid irregularities showing through once the shingles have been laid.

### UNDERLAY (figure 3)

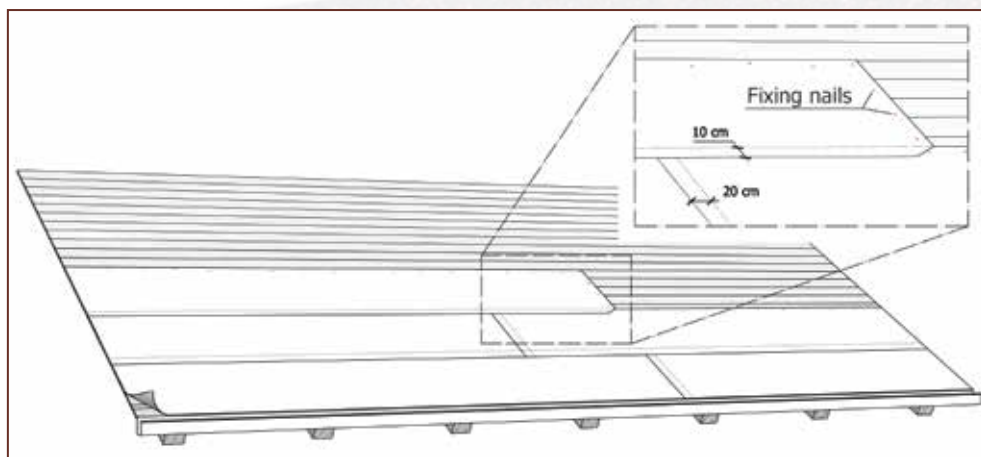

## 8. LAYING THE SHINGLES

Chalk lines act as a guide to help ensure a good result in terms of both appearance and function. Chalk lines act as a visual aid to help you align the shingles correctly both horizontally and vertically.

They also aid in laying shingles around chimneys and dormers.

Horizontal lines can be drawn in courses of four or five shingles; you will need to draw a vertical line when laying shingles over a large area.

Lay shingles starting from the eaves line, working from left to right (see figures 4 and 4.1).

### Notes/tips:

*Bend the pack of shingles slightly before opening it to make the shingles easier to separate.  
Pick shingles from different packs at random.*

### Starter course

Prepare the starter course by cutting the POLYTEGOLA N tabs as illustrated (figures 4 and 4.1).

Lay the starter course with the adhesive strips facing the eaves, cutting the first shingle in half so that the seams will not line up with the seams of the first course of shingles.

Polyseal cartridge-type bituminous sealant should be used to secure and seal the starter course properly on the deck (figure 6).

### First course

Start with a full shingle, laying it flush with the starter course at the eaves and the rake edge (figures 4 and 4.1).

Next fix the shingles as directed in the relevant chapter.

### Second course

Cut a shingle by half a tab and start laying from the rake edge (figures 4 and 4.1). You can take the top notch as your reference.

Shingles must be suitably overlapped as indicated in the relevant table.





### Third and subsequent courses

Start the third course with a shingle that has had one whole tab cut off. For each subsequent course, cut the first shingle by half a tab (figures 4 and 4.1).

To provide the best possible protection from wind and rain, shingles should be sealed with Polyseal at the roof edge.

### LAYING RECTANGULAR POLYTEGOLA N (figure 4)

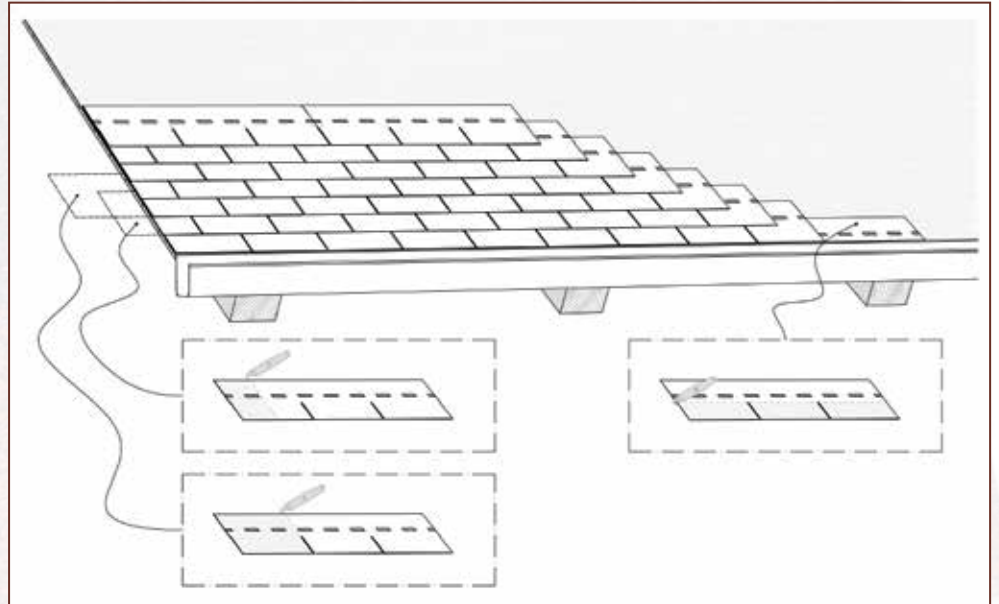

### LAYING BEAVER TAIL POLYTEGOLA N (figure 4.1)

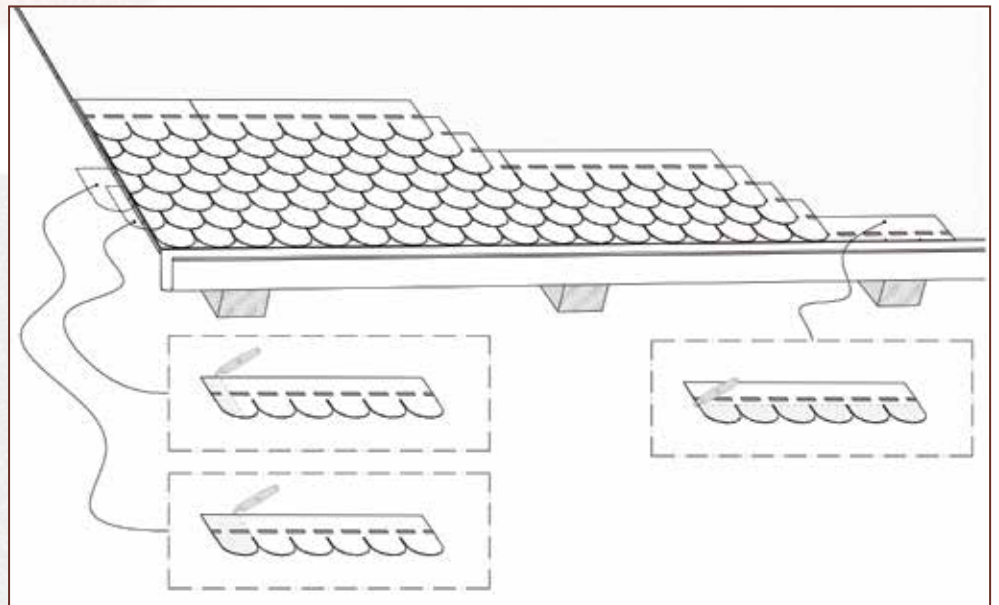

## 9. FIXING THE SHINGLES

Each individual POLYTEGOLA N must be mechanically fixed to the deck using specific broad-headed (9-11mm head) corrosion-resistant nails 20-25 mm long, to be positioned 2.5 cm above the notch line.

On roofs with a pitch up to 60°, each shingle must be fastened with 4 nails.

On roofs with a pitch greater than 60° or exposed to strong winds, each shingle requires 6-7 nails and we recommend sealing each tab with Polyseal mastic.



Refer to figures 5 and 5.1.

Additional use of Polyseal mastic is also recommended when laying shingles during periods of cold weather.

Nails must be driven in at a right angle to the deck, making sure the nail head does not penetrate the shingle, but sits flush with it.

Shingles must be nailed on only; they cannot be "torched on", hot-welded or cold-glued.

### FIXING RECTANGULAR POLYTEGOLA N (figure 5) Roof pitch ranging from 15° to 60°

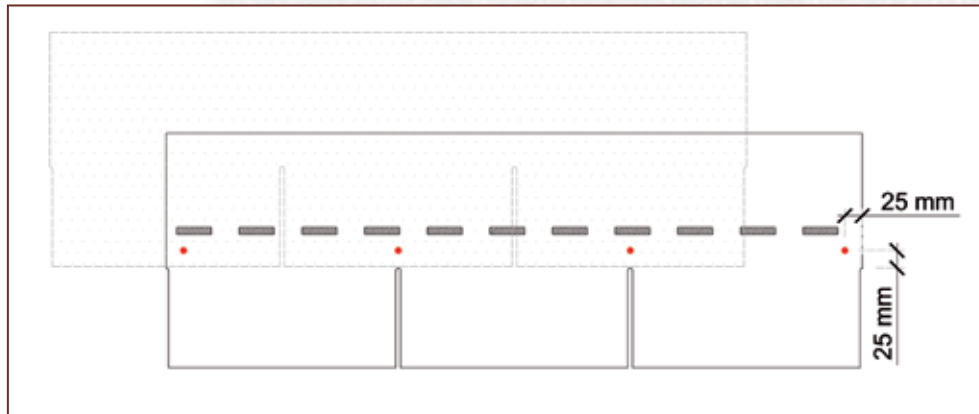

### Roof pitch ranging from 60° to 85°

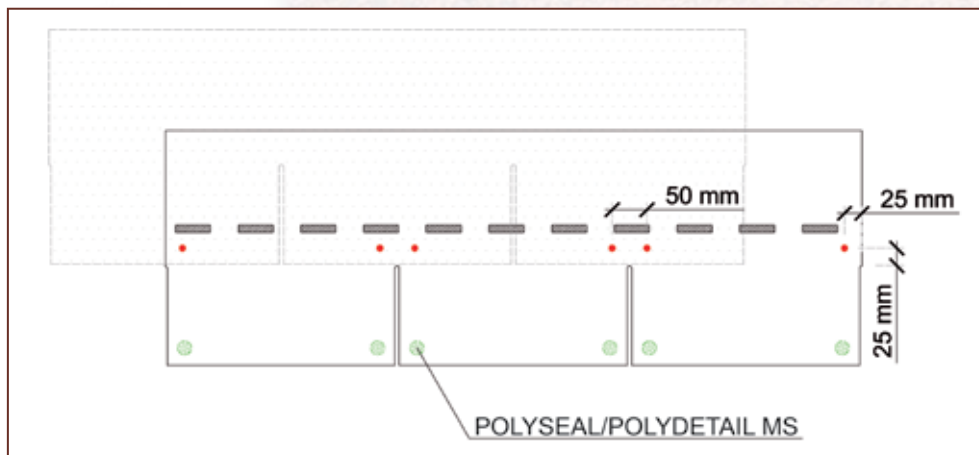

### FIXING BEAVER TAIL POLYTEGOLA N (figure 5.1) Roof pitch ranging from 15° to 60°

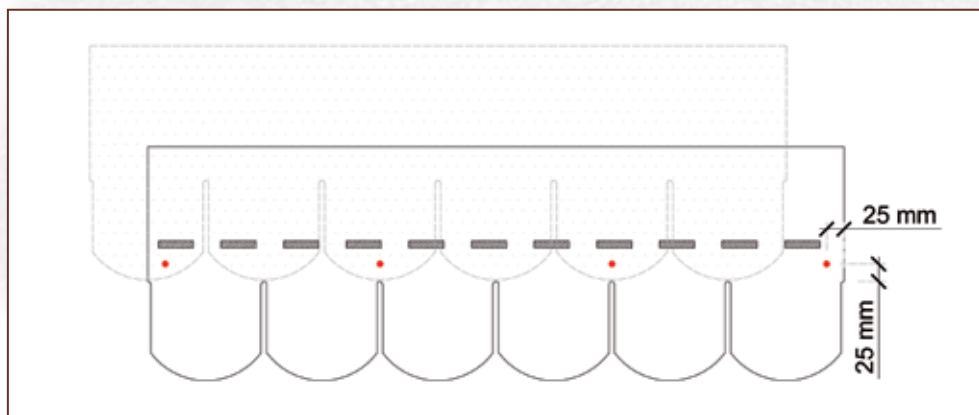



## Roof pitch ranging from 60° to 85°

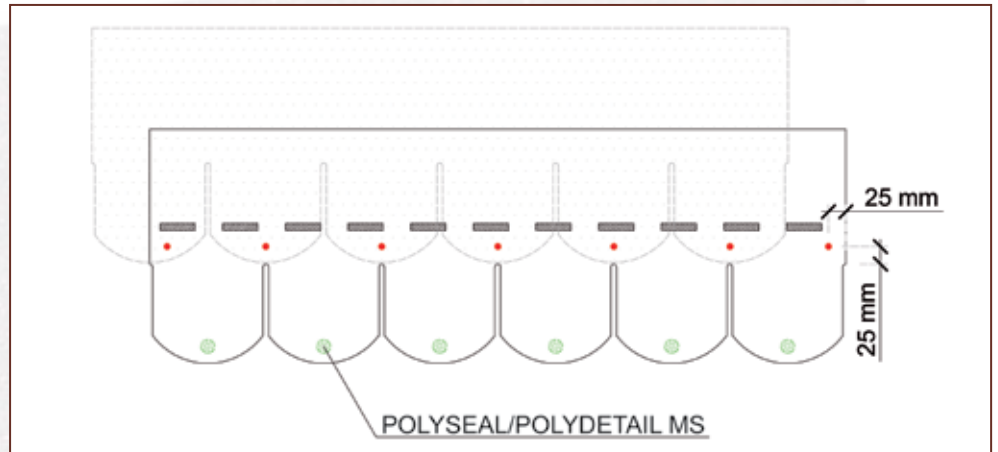

## 10. EAVES LINE

For best results when securing the first starter course to the deck, you are advised to apply Polyseal cartridge-type bituminous sealant (figure 6).

### EAVES DETAIL (figure 6)

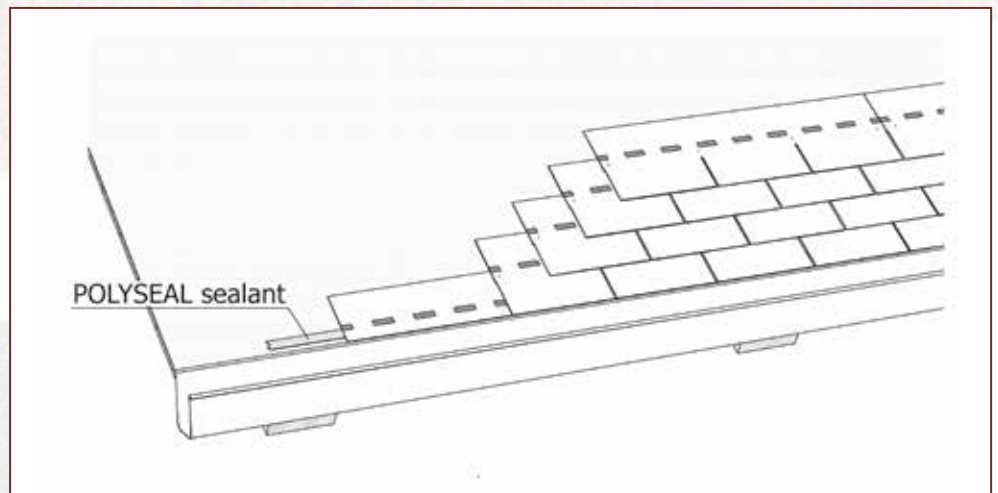

## 11. RIDGE AND HIP LINE

Shingles must straddle the ridge line and be applied and overlapped so that they face away from the prevailing wind.

The individual rectangular shingles must be cut as illustrated in figures 7 and 8, folded over and placed over the ridge or hip.

**When using beaver tail POLYTEGOLA N shingles, the ridge and hip must again be done using rectangular shingles. In cold weather, it is best to warm the underside of the shingles before folding them.**

Fix the ridge mechanically 16 cm from the end of the tab and 2.5 cm from each side edge. Make sure the nails are not left exposed.

For installations exposed to harsh conditions, you may want to apply a continuous line of Polyseal bituminous sealant.

### **Note:**

*For ridge and hip lines, refer to the relevant ventilation chapter.*

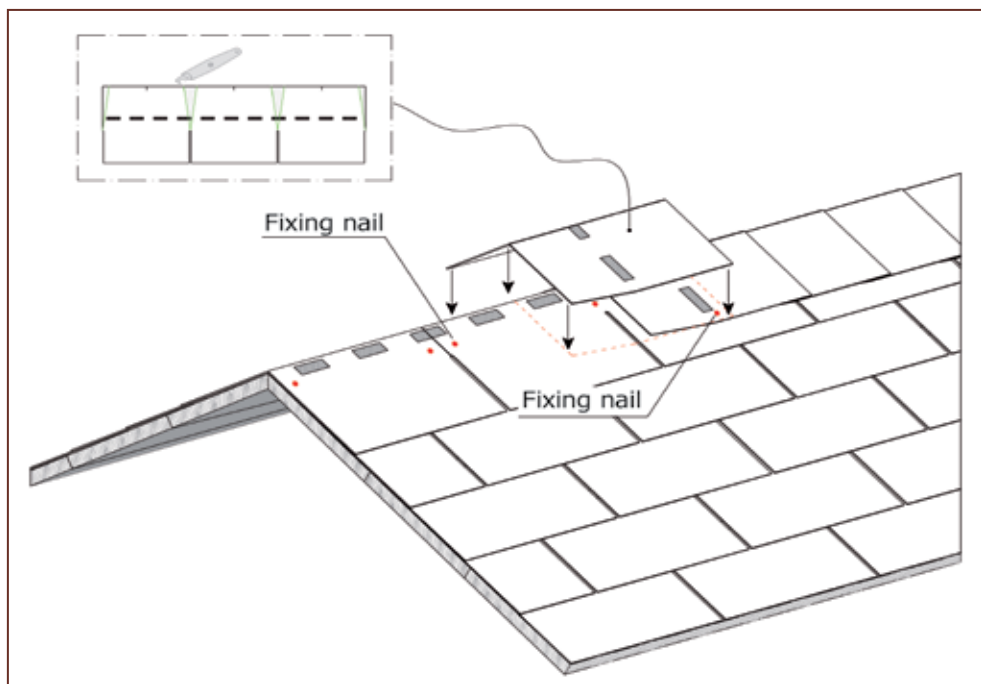
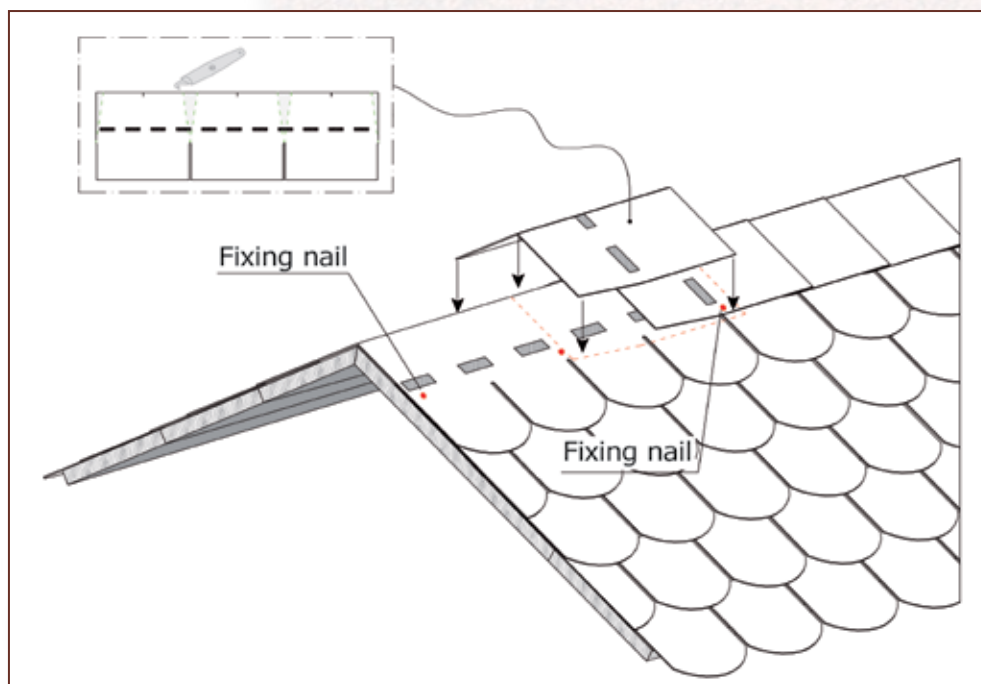

**RECTANGULAR POLYTEGOLA N RIDGE (figure 7)****BEAVER TAIL POLYTEGOLA N RIDGE (figure 8)**

## 12. VALLEYS

First lay a 100cm-wide strip of underlay along the valley and then overlap it by 20 cm with underlay membranes laid horizontally (figure 9).

At the valley joint, shingles must be run across the valley and onto the adjoining roof, weaving them together so that they extend at least 30 cm beyond the valley centre line.

Shingles must be trimmed as illustrated (figure 9). Do not nail in the centre of the valley.

Apply a line of Polyseal mastic to improve the valley's sealing performance.





### VALLEY DETAIL (figure 9)

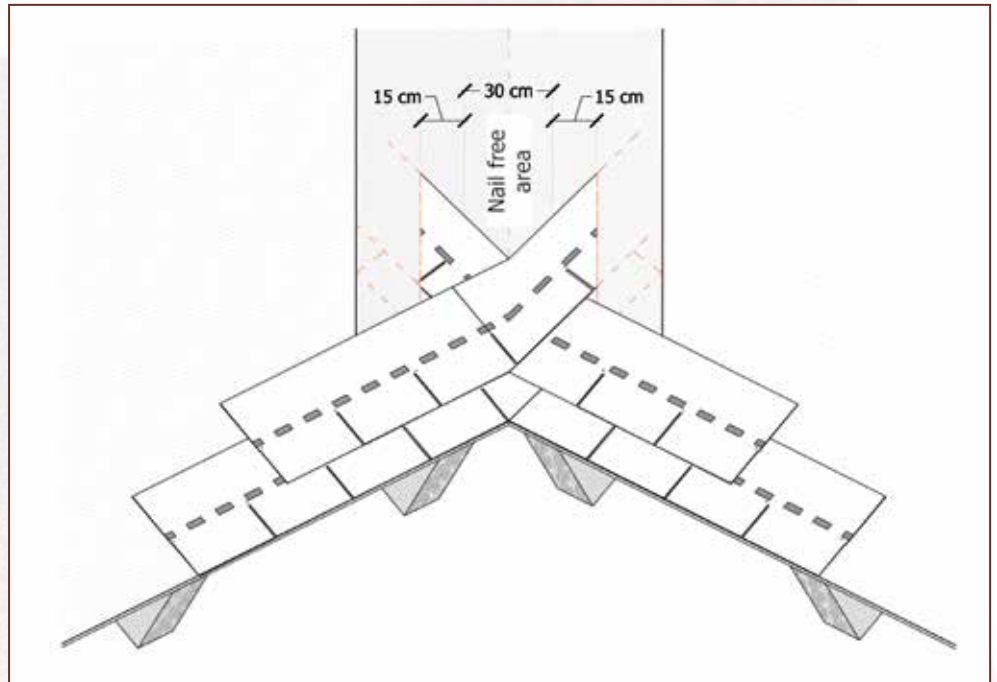

## 13. ROOF EDGE

The roof edge can be finished by applying a triangular or trapezoidal strip of wood for the underlay and shingles to be run over, as illustrated (figure 10). Suitable metal flashing is then used to complete the detail.

Alternatively, a metal drip edge strip can be applied, in which case the shingles must be laid on top with a line of Polyseal bituminous sealant between them (figure 11).

Figures 12 and 13 show two possible solutions when running the roofing system up against a wall.

### ROOF EDGE DETAIL (figure 10)

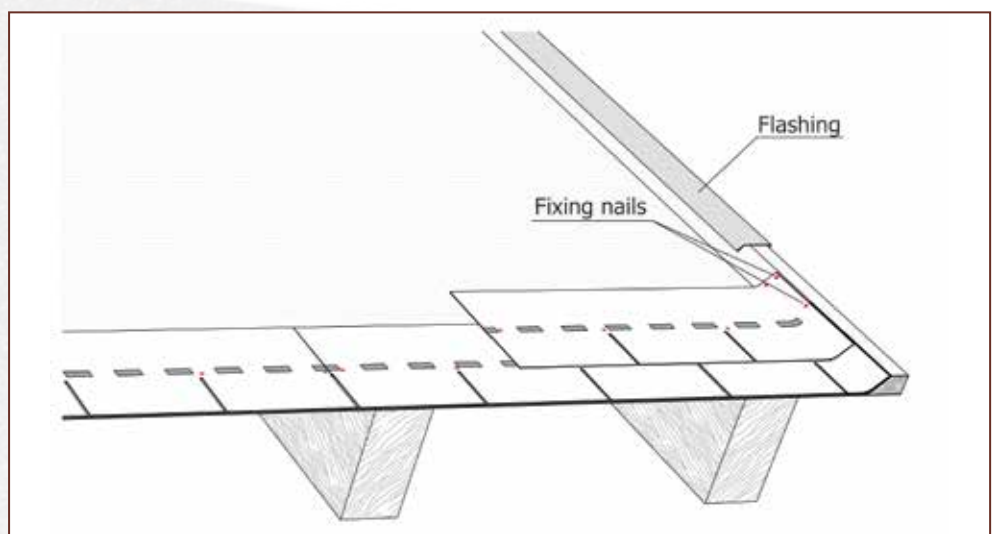



**ROOF EDGE DETAIL (figure 11)**

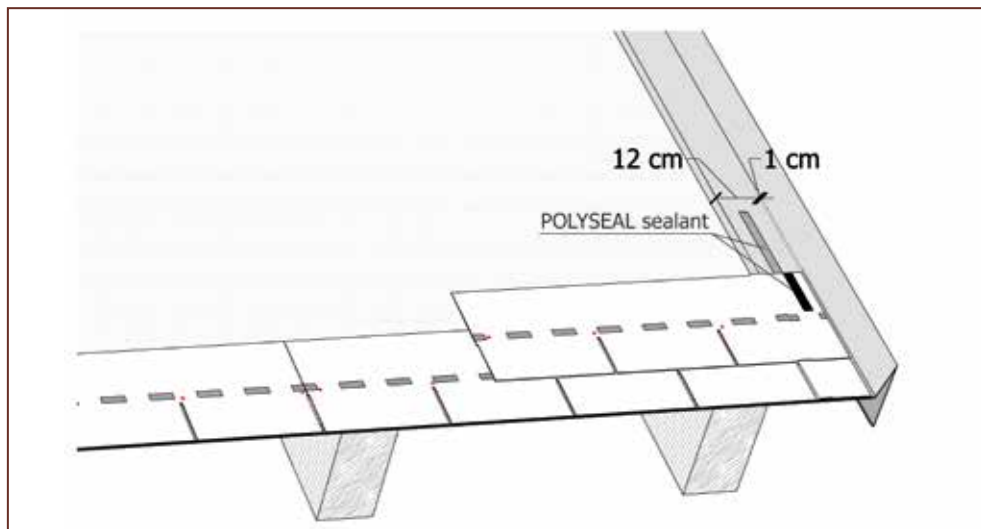

**ROOF EDGE DETAIL (figure 12)**

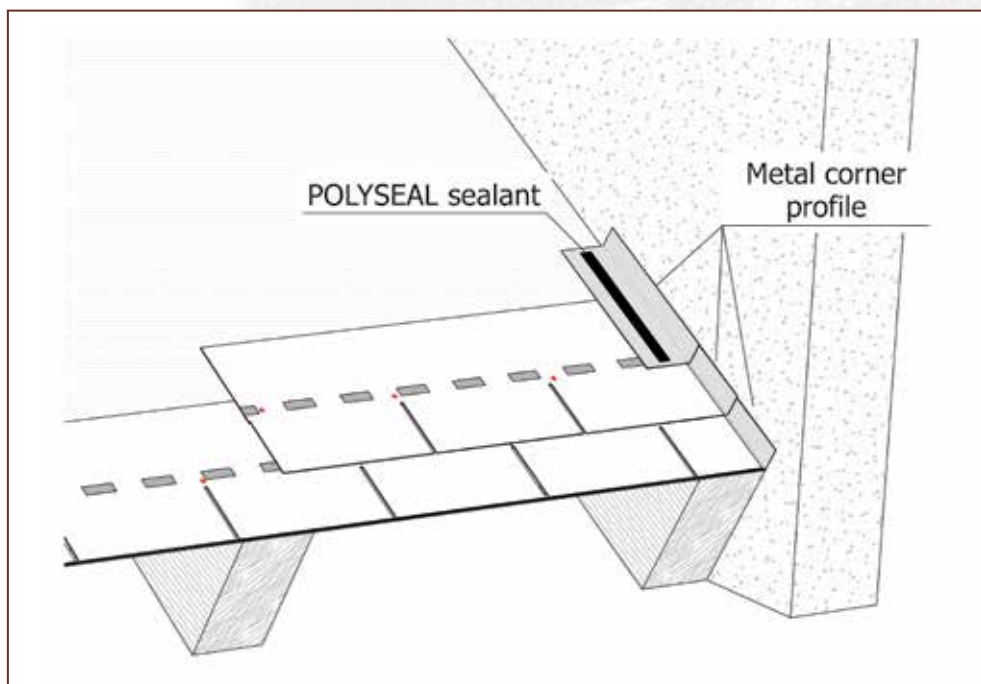



**ROOF EDGE DETAIL (figure 13)**

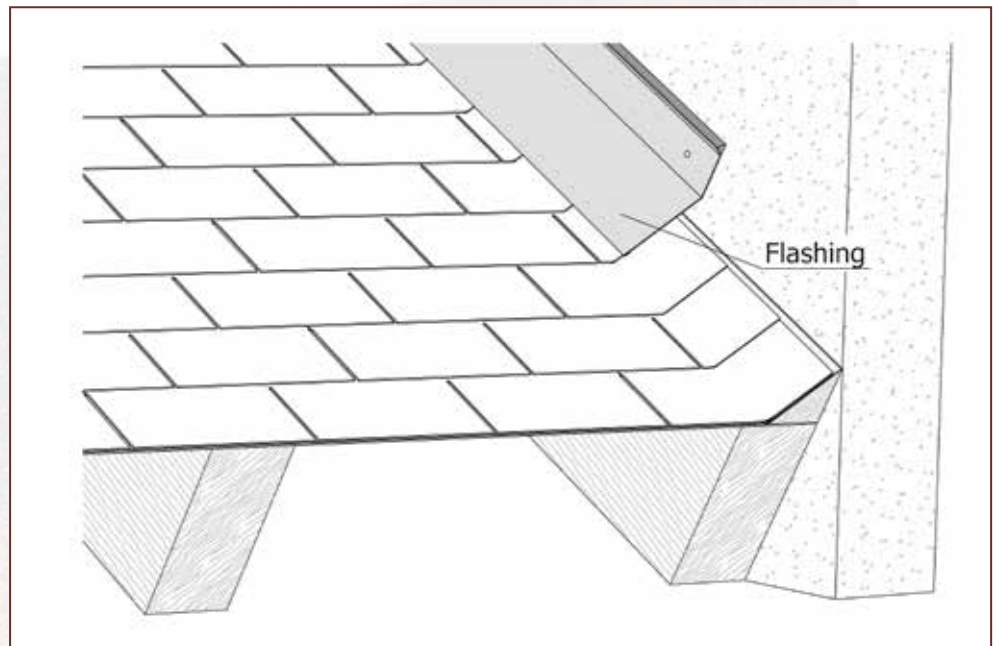

## 14. CHIMNEY JUNCTION

The junction between roofing systems and chimneys is produced by applying specific flashing with a drip channel. Shingles must be applied and connected to the flashing using Polyseal bituminous sealant (figure 14).

**CHIMNEY JUNCTION DETAIL (figure 14)**

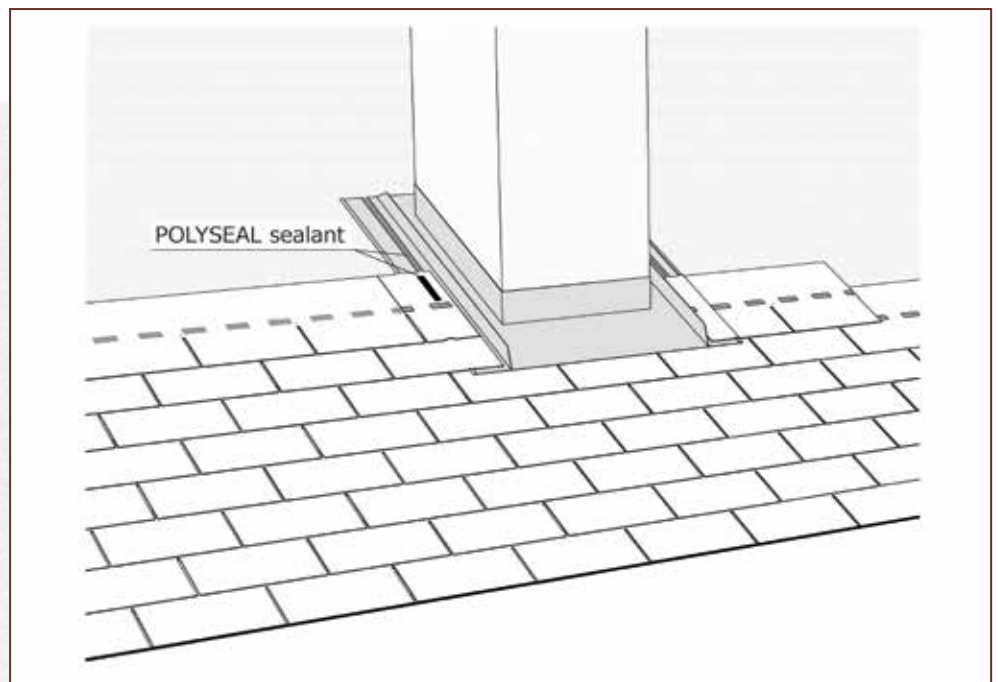



## 15. GLOSSARY

Below is a list of terms used in this manual.

1. Exposure
2. Top lap, hidden part
3. Slit
4. Self-adhesive strip
5. Tab
6. Notch

### **GLOSSARY (figure 15)**

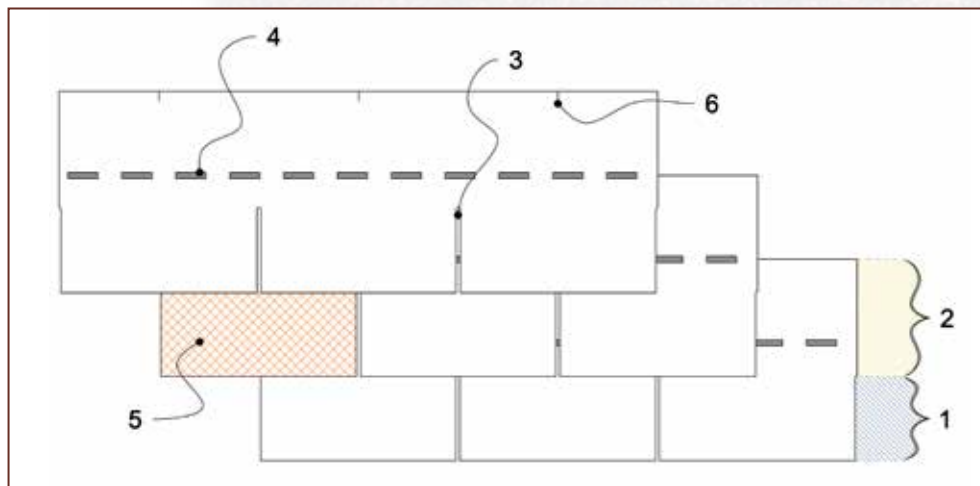



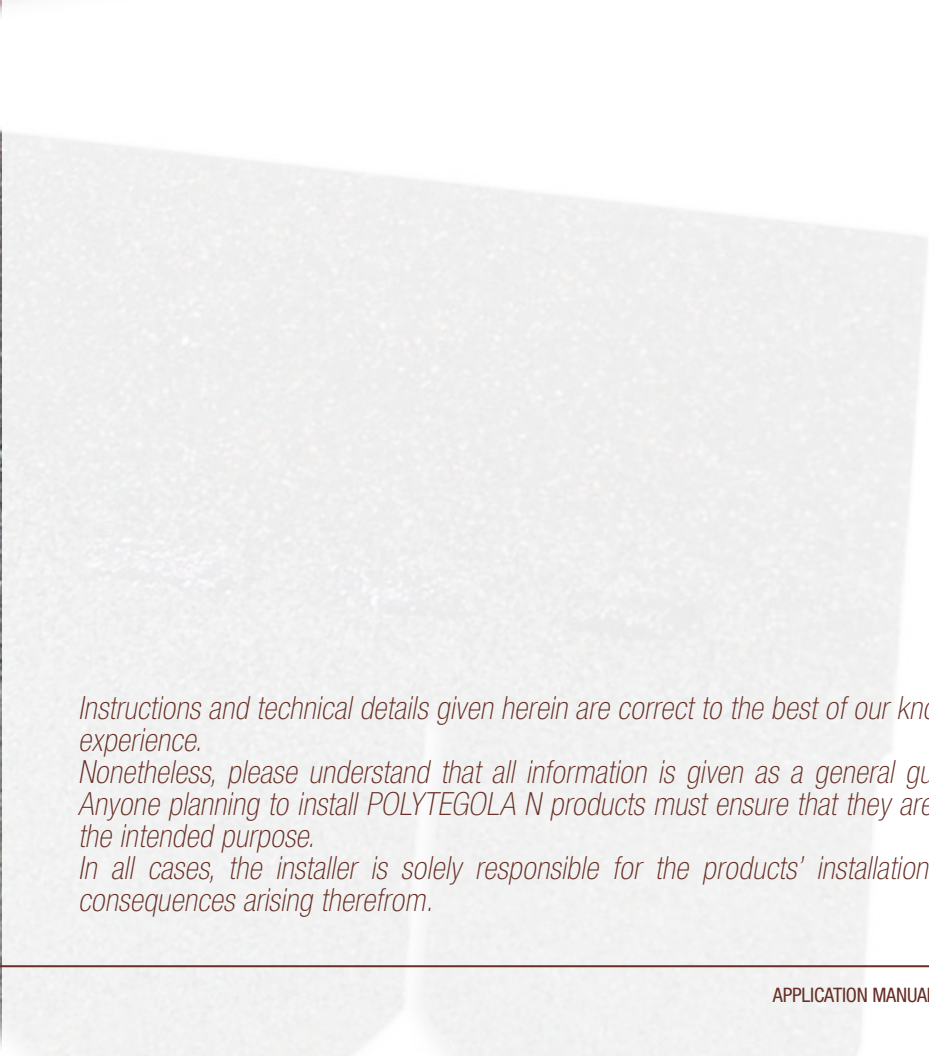

*Instructions and technical details given herein are correct to the best of our knowledge and experience.*

*Nonetheless, please understand that all information is given as a general guideline only. Anyone planning to install POLYTEGOLA N products must ensure that they are suitable for the intended purpose.*

*In all cases, the installer is solely responsible for the products' installation and for all consequences arising therefrom.*



**POLYGLASS SPA**

Registered Office: Viale Jenner, 4 - 20159 Milano  
Head Office: Via Giorgio Squinzi, 2 - 31047 Ponte di Piave (TV)  
Tel. +39 04227547 - Fax +39 0422854118  
[www.polyglass.com](http://www.polyglass.com) - [info@polyglass.it](mailto:info@polyglass.it)

**POLYGLASS®**

