



Technical Book

WATERPROOFING SYSTEM

**FOR BALLASTED ROOF, PEDESTRIAN ROOF
AND PARKING DECK**

MAPEPLAN T B

**WATERPROOFING SYSTEM
FOR BALLASTED ROOF
MAPEPLAN T B**



INDEX

page	05	1. Foreword
page	07	2. Polyglass SpA
page	08	3. Ballasted roof, pedestrian roof, parking deck
page	14	4. MAPEPLAN T B solutions - New roof
page	31	5. MAPEPLAN T B solutions - Refurbishment
page	40	6. Basic requirements of synthetic waterproofing membranes for ballasted roof, pedestrian roof, parking deck
page	42	7. MAPEPLAN T B waterproofing membrane
page	49	8. Advantages of loose laid application with ballast
page	52	9. Installation instructions
page	54	10. MAPEPLAN T system accessories
page	60	11. Technical drawings

**WATERPROOFING SYSTEM
FOR BALLASTED ROOF
MAPEPLAN T B**



1. Foreword

The aim of this Technical Book is to provide technical, design and construction information and solutions for the correct installation of ballasted roof, pedestrian roof and parking deck waterproofing and thermal insulation systems, with the use of MAPEPLAN T B flexible polyolefin (FPO/TPO) synthetic waterproofing membranes.

Waterproofing systems are a key factor in the construction of a ballasted roof. Indeed, a successful build starts with the waterproofing system, which must ensure a perfect seal, functionality and long service life, otherwise all the work that has gone in to creating a superior standard of roof will be negated by leak issues.

This document, therefore, will be covering in depth aspects relating to thermal insulation/waterproofing systems using MAPEPLAN T B flexible polyolefin (FPO/TPO) synthetic membranes. We will also be giving a more general overview - but with as much information as possible - of the construction of the ballast layer and paving for pedestrians or vehicles. There are various systems and technical solutions available on the market, all of which are effective and functional, so we will leave it up to you to determine which best suits your needs. Remember, no matter which ballasted roof and paving you choose, you can still apply MAPEPLAN T B waterproofing systems underneath.

Note

For green roof application we direct your attention to the specific technical book "WATERPROOFING SYSTEMS FOR GREEN ROOFS MAPEPLAN T B".

**WATERPROOFING SYSTEM
FOR BALLASTED ROOF
MAPEPLAN T B**



2. Polyglass SpA

POLYGLASS SpA is one of the leading and most active European manufacturers of waterproofing systems using FPO/TPO and PVC-P synthetic membranes and polymer distilled bitumen membranes.

We were the first Italian manufacturer to venture into the world market, with Polyglass products and technologies present in over 40 countries.

Our main manufacturing facility is in Ponte di Piave in the province of Treviso in Italy's Northeast, which is also home to our company headquarters.

POLYGLASS SpA is part of the MAPEI Group, an international construction chemicals giant that, at the end of March 2020, comprises 90 subsidiaries, 31 main R&D centres, including 1 corporate centre, and 83 manufacturing sites operating in 36 countries on five continents, each with its own quality control laboratory.

POLYGLASS waterproofing systems are distributed and applied successfully worldwide, exposed to a whole range of different and critical environmental and service conditions.

POLYGLASS SpA has been an ISO 9001-certified company since 1995 and ISO 14001-certified since 2010 and is a member of the Green Building Council Italia.



All POLYGLASS products can help earn credits for LEED certification of buildings.

3. Ballasted roof, pedestrian roof, parking deck

The ballasted roof, pedestrian roof or parking deck, carried out with waterproofing membrane MAPEPLAN T B are typical laid, totally independent from the build-up (loose laid application), in fact all layers are hold down by an upper ballast.

The ballast layer must be designed to contrast the wind uplift force and eventually designed as a paving for pedestrian or vehicle traffic. It can be made only on flat roofs with an available permanent overload $\geq 75 \text{ kg/m}^2$.

The ballast layer can be made with:

- Round gravel washed with dimensions 16-32 mm or fragmented gravel with dimensions 8-10 mm, laid with a minimum thickness of 5 cm
- Pedestrian floating pavement with elements raised on supports
- Concrete screed with tile paving for pedestrian traffic
- Concrete screed with asphalt surface course for vehicles traffic
- Paving stone laid on sand for vehicles traffic

The ballast type of roof can be accessible only for maintenance, for pedestrian use, or accessible for vehicles traffic, according to the type of ballast used.

Key functional layers of a ballasted roof, pedestrian roof or parking deck

The typical build-up of a ballasted roof, pedestrian roof or parking deck, waterproofed with synthetic membranes, without insulation layer, is relatively simple. The key functional layers are described below.

Load-bearing structural support

The load-bearing structural support must be sized to withstand permanent loads due to the weight of the ballast layer or paving and accidental overloading if the roof is accessible and usable (people and/or vehicle access). Various kinds of load-bearing structural support can be used, such as a traditional or prefabricated reinforced concrete deck, a composite steel deck or timber deck. Depending on the construction type, the load-bearing structure can have different slope, more or less emphasized.

If the structure have not a sufficient inclination, the slope must be carried out with concrete screed done directly on structural deck, or with an adequate disposition of sloped insulation panels.

Levelling layer

The purpose of the levelling layer is to level out and compensate for protuberances and unevenness in the surface the roof is being installed on in order to avoid the risk of the waterproofing membrane being punctured. This layer is produced using geotextiles with a suitable weight and relevant properties.

Waterproofing layer

The purpose of the waterproofing layer is to stop rainwater getting inside, as well as protecting the loadbearing structural support from deterioration. This layer must be resistant to stress action, originated to the type of roof and ballast layer, resistant to microorganism action and resistant to substance and root penetration that it might come into contact with.

Protection layer

The purpose of the protection layer is to protect the waterproofing layer from mechanical damage. The waterproofing system is exposed to the risk of mechanical damage both during the building of the roof and while it is in service. In an inverted roof the insulation layer, that is laid above the waterproofing layer, carry out also the protective function.

Separation and anti-soaking layer (if necessary)

When a concrete screed is poured above the waterproofing layer, a separation and anti-soaking layer is necessary. This layer is put before the concrete screed to prevent the obstruction of the underlying protection layer. Normally it is done with a low-density (LDPE) micro-perforated polyethylene, the microperforation allows the vapor permeability.

Ballast layer

The key function of the ballast layer is to contrast the wind uplift force and to avoid the separation or lifting of part or some of the roof build-up elements. The ballast layer can be made with a mobile heavy protection such as gravel, floating pavements or paving stones laid on sand, or even with an unmovable heavy protection such as tile flooring over concrete screed, or concrete screed with an asphalt surface.

Note: when a concrete screed is required, a compressible expanded element must be put all along the perimeter zone and the vertical parts of the roof, in order to prevent mechanical damages on the vertical waterproofing surfaces due to thermal dilatation of the upper layer. The compressible expanded element must be the same height of the concrete screed thickness and designed with an adequate thickness to contrast eventual dilatation movements.

Sample build-up with key functional layers (without insulation)

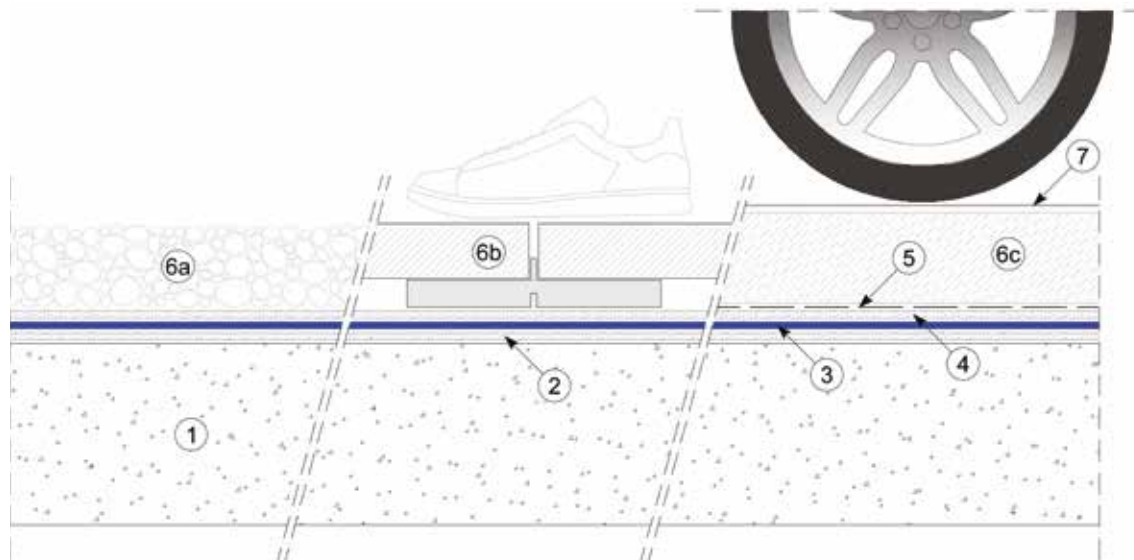

- ① Load-bearing structural support, possibly sloping
- ② Levelling layer
- ③ Synthetic waterproofing membrane
- ④ Protection layer
- ⑤ Separation and anti-soaking layer
- ⑥a Ballast layer with gravel
- ⑥b Floating pavement
- ⑥c Concrete screed
- ⑦ Asphalt surface course or tile flooring

Complementary functional layers of a ballasted roof, pedestrian roof or parking deck with insulation

Building a complete and more well-structured ballasted roof, pedestrian roof or parking deck with insulation, involves the use of certain complementary elements, as described below.

Vapour barrier layer

To be included in the building of a roof with thermal insulation. The purpose of this layer is to control the flow of vapour passing through the structure, from the inside of the building to the outside, in order to avoid the issue of condensation forming inside the roof assembly. It must be applied under the thermal insulation layer.

Thermal insulation layer

To be applied when building thermally insulated roofs. This layer can be produced using the various usual commercially available insulating materials. Suitable compressive strength is one essential requirement of this layer, which must also be compatible with the waterproofing membrane to be applied on top.

Sample build-up with key and complementary functional layers (insulated roof)

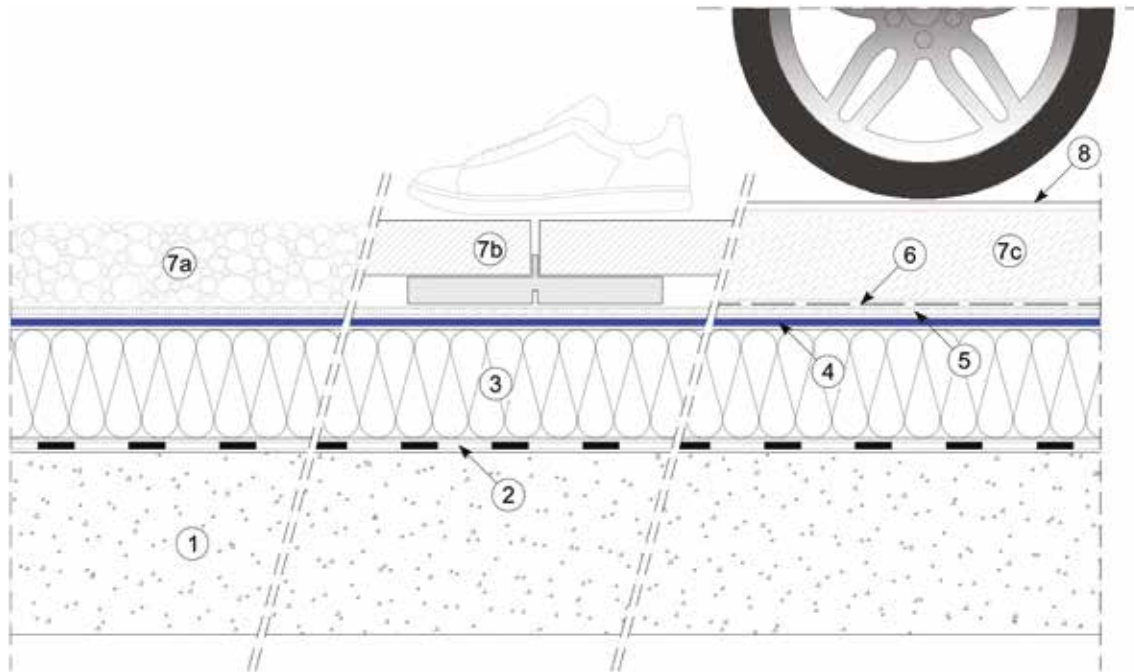

- ① Load-bearing structural support, possibly sloping
- ② Vapour barrier layer
- ③ Thermal insulation layer
- ④ Synthetic waterproofing membrane
- ⑤ Protection layer
- ⑥ Separation and anti-soaking layer
- ⑦a Ballast layer with gravel
- ⑦b Floating pavement
- ⑦c Concrete screed
- ⑧ Asphalt surface course or tile flooring

Complementary functional layers of a ballasted roof, pedestrian roof or parking deck, with insulation as inverted roof

The complementary functional layers of a ballasted roof, pedestrian roof or parking deck with insulation, as inverted roof, are described below.

Thermal insulation layer

The thermal insulation layer, laid on top of the waterproofing membrane, is made with extruded polystyrene insulation panels (XPS) which ensure the minimum water absorption for immersion. The essential requirements for a thermal insulation layer are: adequate compressive strength, dimensionally stable, low water absorption and suitability for contact with the waterproofing membrane.

Note: The thermal insulation layer, laid on top of the waterproofing membrane, ensure additional mechanical protection.

Sample build-up with key and complementary functional layers (inverted roof)

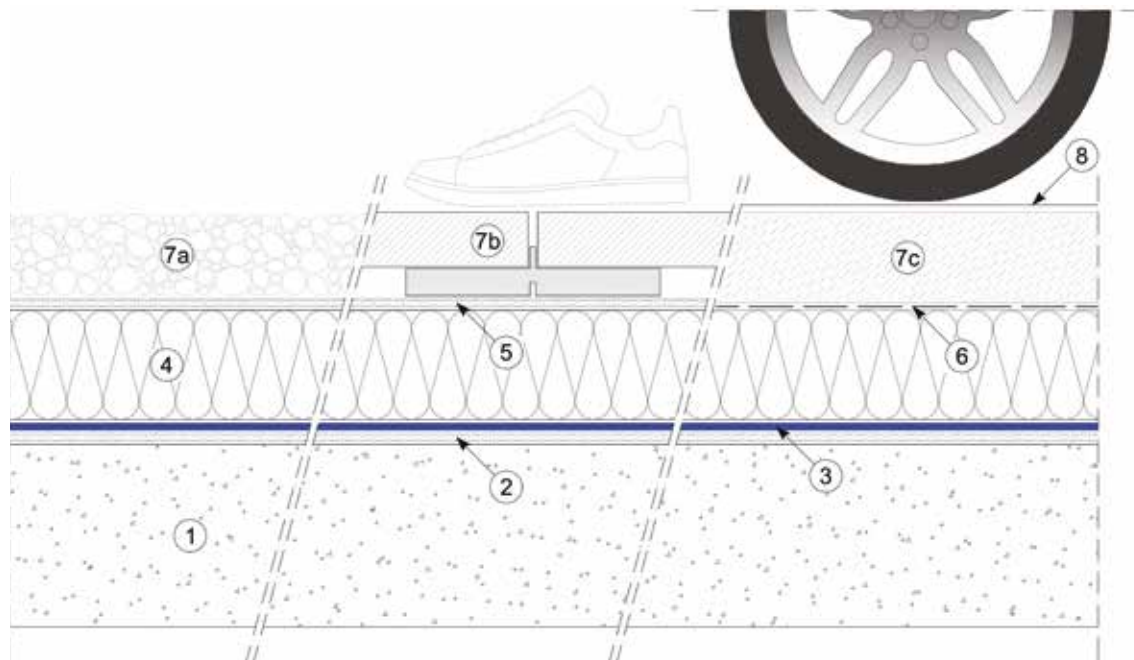

- ① Load-bearing structural support, possibly sloping
- ② Levelling layer
- ③ Synthetic waterproofing membrane
- ④ Thermal insulation layer
- ⑤ Protection layer
- ⑥ Separation and anti-soaking layer
- ⑦a Ballast layer with gravel
- ⑦b Floating pavement
- ⑦c Concrete screed
- ⑧ Asphalt surface course or tile flooring



4. MAPEPLAN T B solutions - New roofs

Using MAPEPLAN T B waterproofing membranes, you can design and build functional, reliable, modern, technologically advanced and exceptionally eco-friendly ballasted roofs, pedestrian roofs and parking deck.

The coming pages feature a series of build-ups showing correct technical solutions with and without thermal insulation.

As you can see, the MAPEPLAN T B waterproofing assembly - which is the roof's actual thermal and waterproofing system - can be applied under all the various types of ballasted roofs, pedestrian roofs and parking deck build-ups available on the market.

Please find below a few technical issues that we have factored in when formulating the MAPEPLAN T B build-ups and solutions given.

No risk of condensation

Appropriate measures that can/must be taken to avoid the risk of condensation involve correctly sizing the vapor barrier and thermal insulation layer. With a proper hygrothermal analysis, the designer can determine the correct size of the thermal insulation and waterproofing assembly.

Our MAPEPLAN T B technical solutions involve the use of vapor barriers produced by POLYGLASS (POLYVAP SA P-AL - POLYVAP RADONSHIELD P-AL - PLANA P - POLYVAP FIX P-AL - POLYVAP FIX P) bitumen membranes or polyethylene foil MAPEPLAN VB PE SD 220, that have a suitable controlled water vapor transmission value (Sd value). A secondary advantage of vapor barriers made with bitumen is that they also serve as a provisional waterproofing measure, before the full system is implemented.

Minimum requirements of thermal insulation panels

The thermal insulation panels normally used in the building industry are generally also suitable for building ballasted roofs, pedestrian roofs and parking deck (you are advised to refer to the technical literature and directions issued by the individual manufacturers).

In our technical solutions, we generally indicate the thermal insulation layer so that the designer, builder and customer can decide on the product they deem best meets their needs and demands.

Whatever the case, thermal insulation panels must meet the following minimum requirements:

- Must have adequate compressive strength, which will need to be checked against the anticipated loads and overloading.
- Must be highly dimensionally stable.
- In the case of "inverted roof" applications - where the thermal insulation is not protected by the waterproofing membrane - you will need to use suitable extruded polystyrene (XPS) panels certified for this kind of application.

BUILD-UP T B1.0

MAPEPLAN T B membrane – Non-insulated roof ballasted with gravel

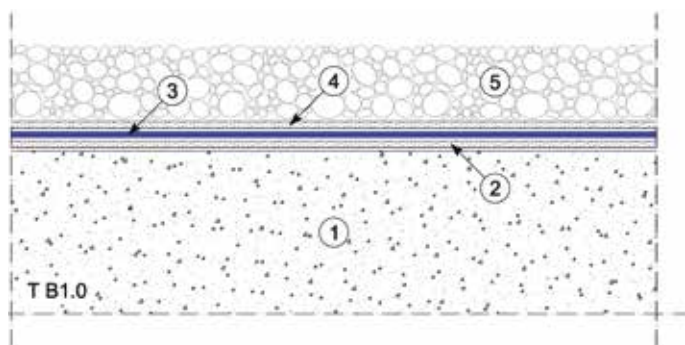
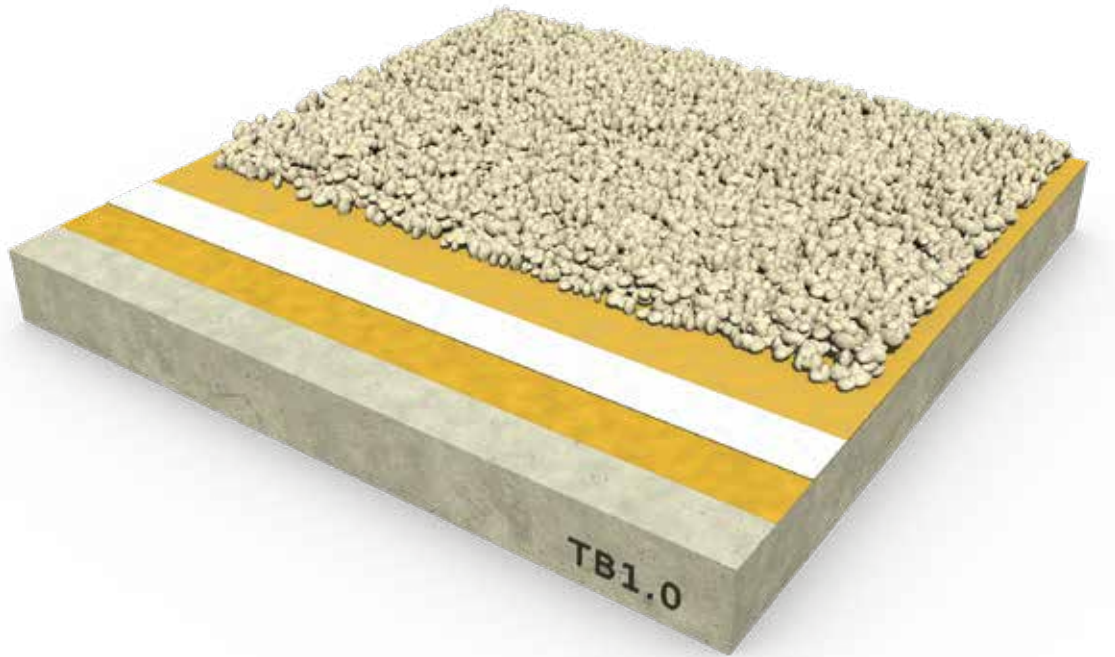

- ① Structure
- ② **POLYDREN PP** levelling layer
- ③ **MAPEPLAN T B** waterproofing membrane
- ④ **POLYDREN PP** protection layer
- ⑤ Ballast layer - Gravel

BUILD-UP T B1.1

MAPEPLAN T B membrane - Insulated roof ballasted with gravel

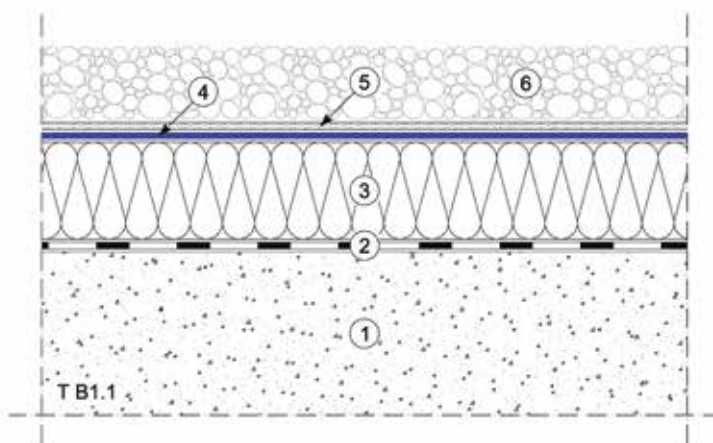
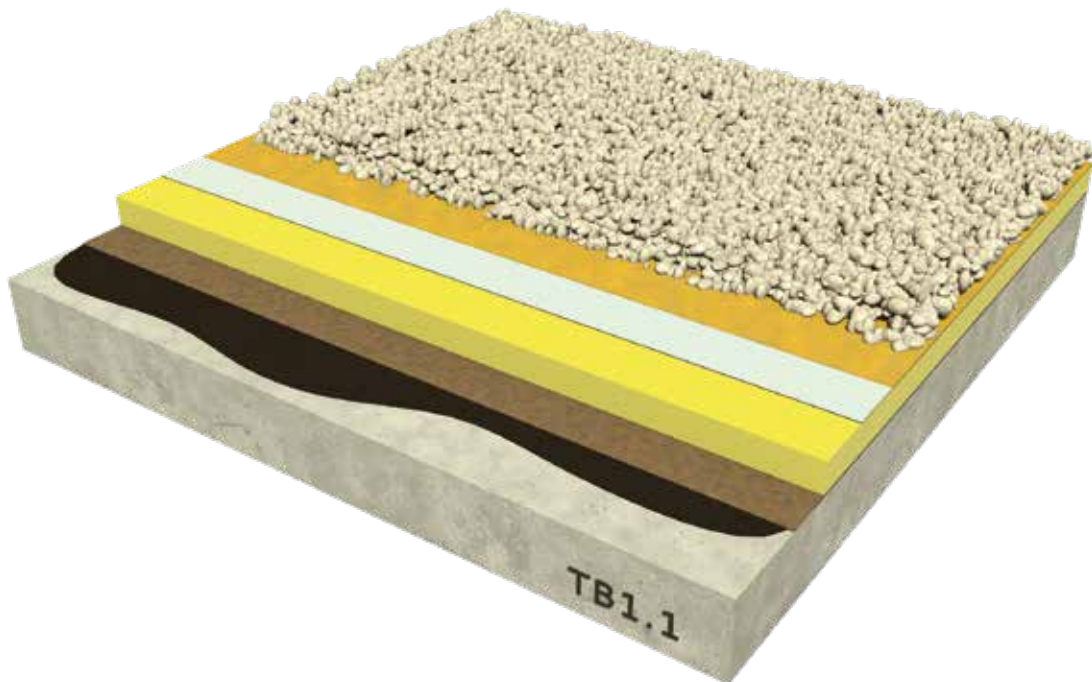

- ① Structure
- ② Vapour barrier layer (e.g. **MAPEPLAN VB PE SD 220** or **IDROPRIMER + POLYVAP**)
- ③ Thermal insulation layer
- ④ **MAPEPLAN T B** waterproofing membrane
- ⑤ **POLYDREN PP** protection layer
- ⑥ Ballast layer - Gravel

BUILD-UP T B1.2

MAPEPLAN T B membrane - Inverted roof ballasted with gravel

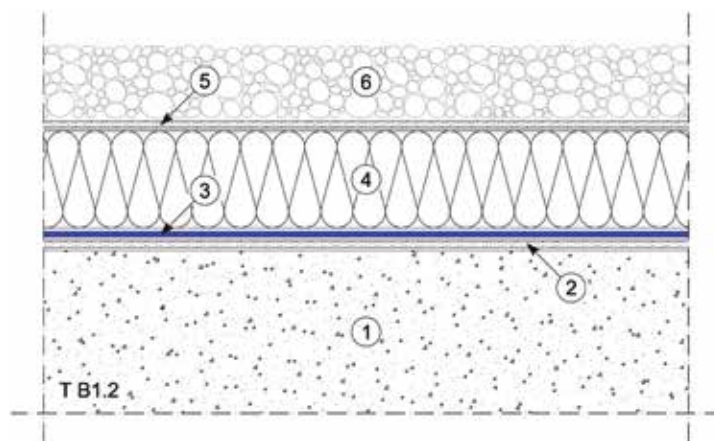
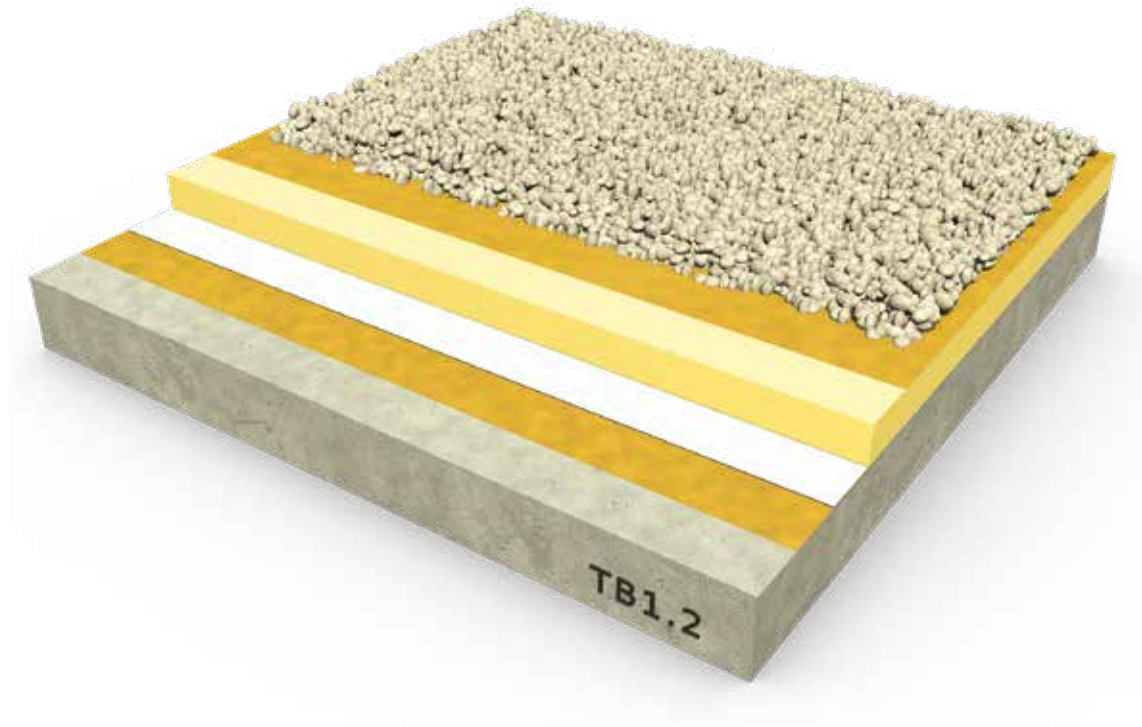

- ① Structure
- ② **POLYDREN PP** levelling layer
- ③ **MAPEPLAN T B** waterproofing membrane
- ④ Thermal insulation layer XPS
- ⑤ **POLYDREN PP** filter layer
- ⑥ Ballast layer - Gravel

BUILD-UP T B2.0

MAPEPLAN T B membrane - Non-insulated roof ballasted with floating pavement

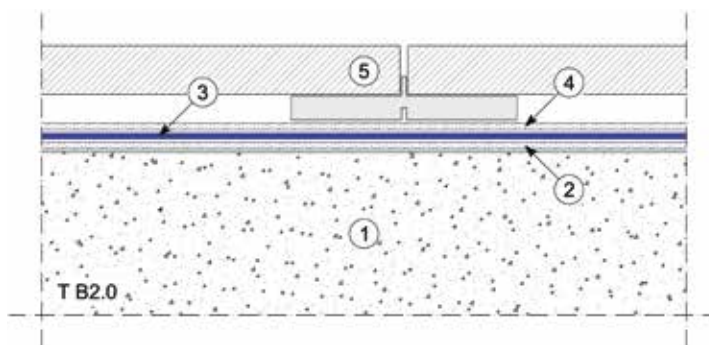
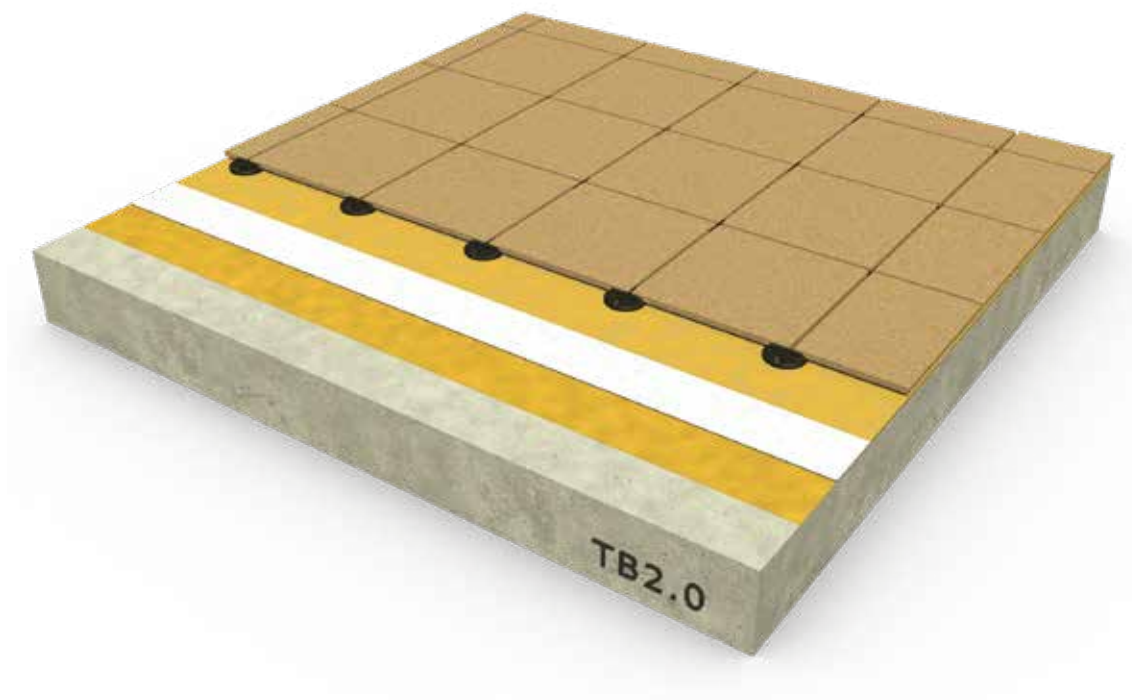

- ① Structure
- ② **POLYDREN PP** levelling layer
- ③ **MAPEPLAN T B** waterproofing membrane
- ④ **POLYDREN PP** protection layer
- ⑤ Ballast layer - Floating pavement

BUILD-UP T B2.1

MAPEPLAN T B membrane - Insulated roof ballasted with floating pavement

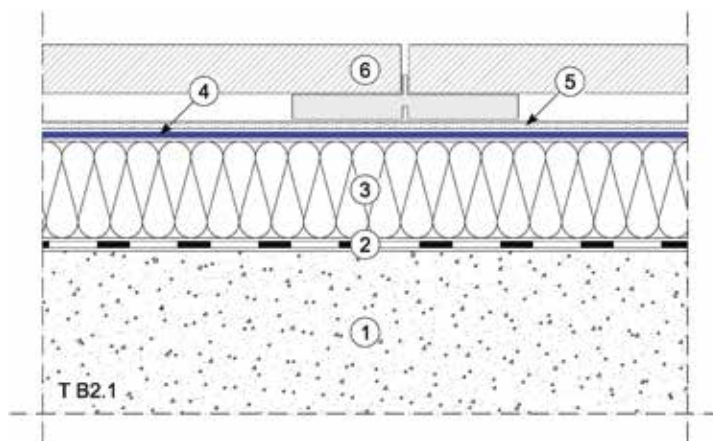
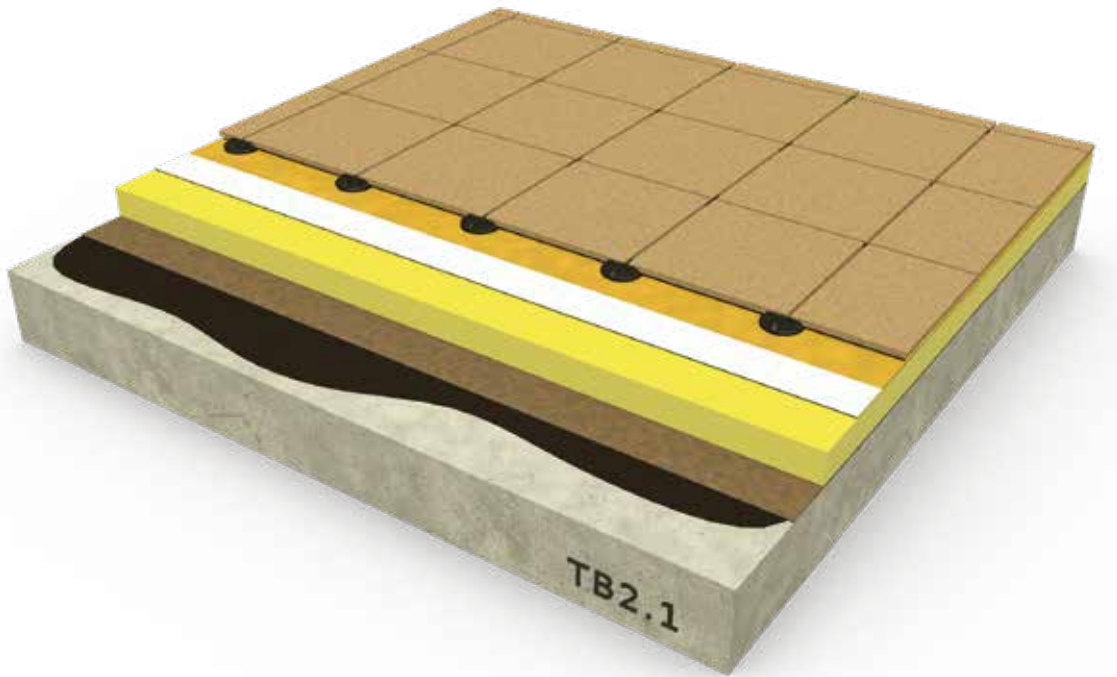

- ① Structure
- ② Vapour barrier layer (e.g. **MAPEPLAN VB PE SD 220** or **IDROPRIMER + POLYVAP**)
- ③ Thermal insulation layer
- ④ **MAPEPLAN T B** waterproofing membrane
- ⑤ **POLYDREN PP** protection layer
- ⑥ Ballast layer - Floating pavement

BUILD-UP T B2.2

MAPEPLAN T B membrane - Inverted roof ballasted with floating pavement

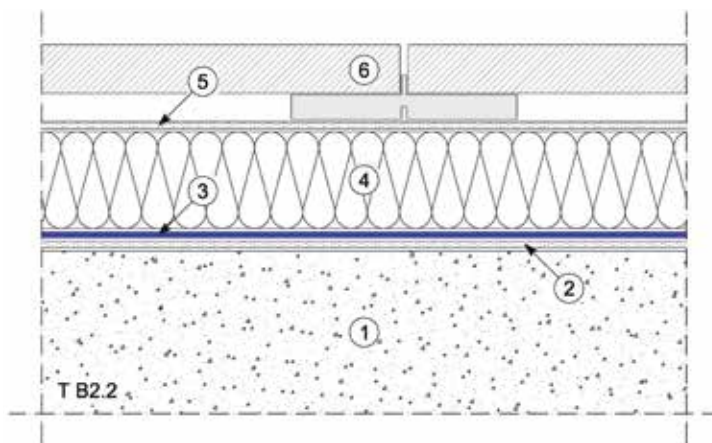
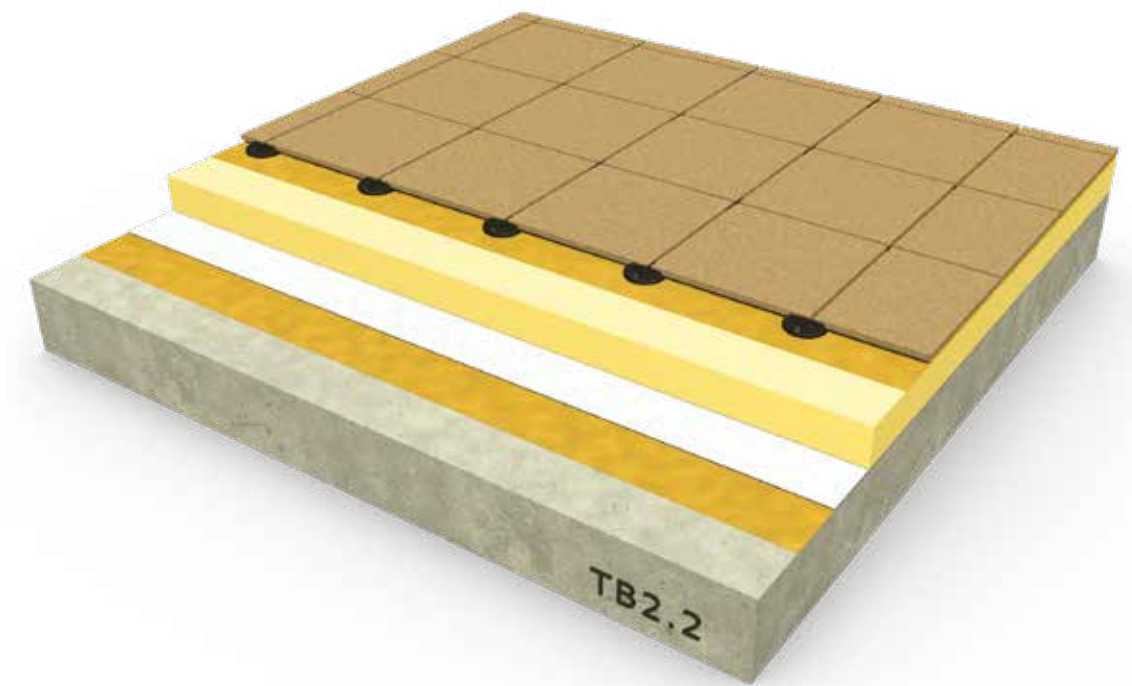

- ① Structure
- ② **POLYDREN PP** levelling layer
- ③ **MAPEPLAN T B** waterproofing membrane
- ④ Thermal insulation layer XPS
- ⑤ **POLYDREN PP** filter layer
- ⑥ Ballast layer - Floating pavement

BUILD-UP T B2.3

MAPEPLAN T B membrane - Non-insulated roof ballasted with floating pavement

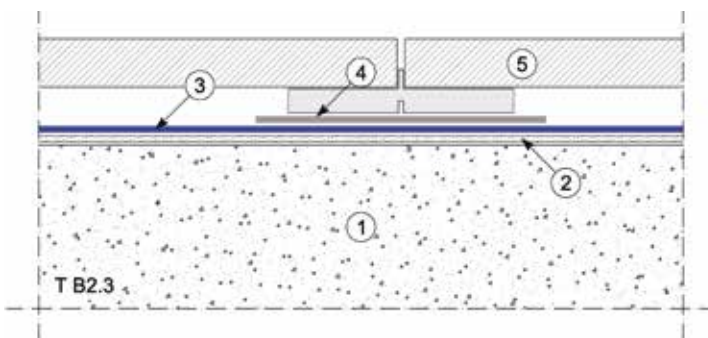
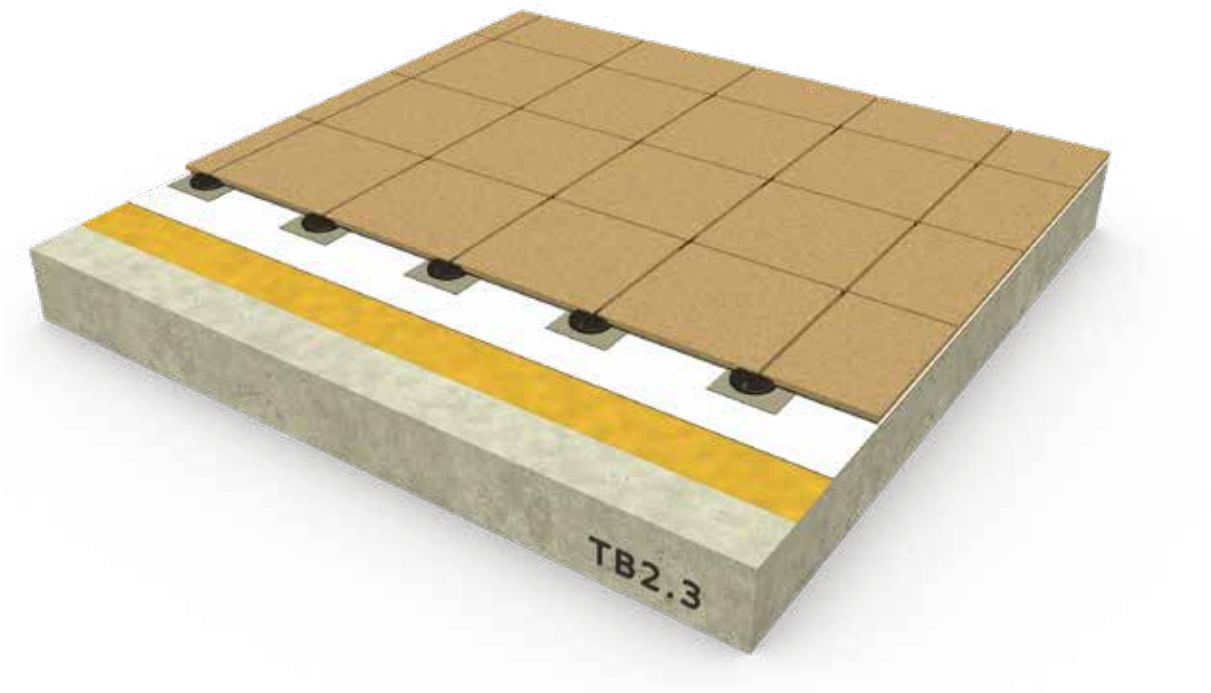

- ① Structure
- ② **POLYDREN PP** levelling layer
- ③ **MAPEPLAN T B** waterproofing membrane
- ④ **MAPEPLAN T** protection patch
- ⑤ Ballast layer - Floating pavement

BUILD-UP T B2.4

MAPEPLAN T B membrane - Insulated roof ballasted with floating pavement

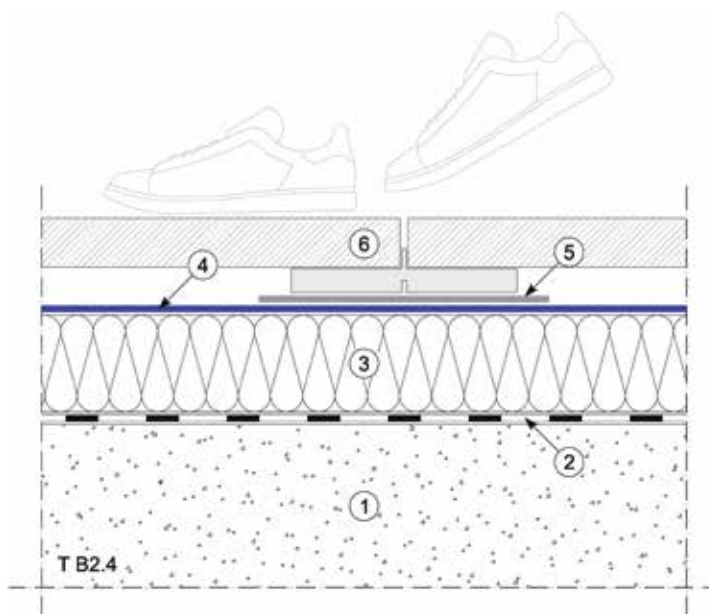
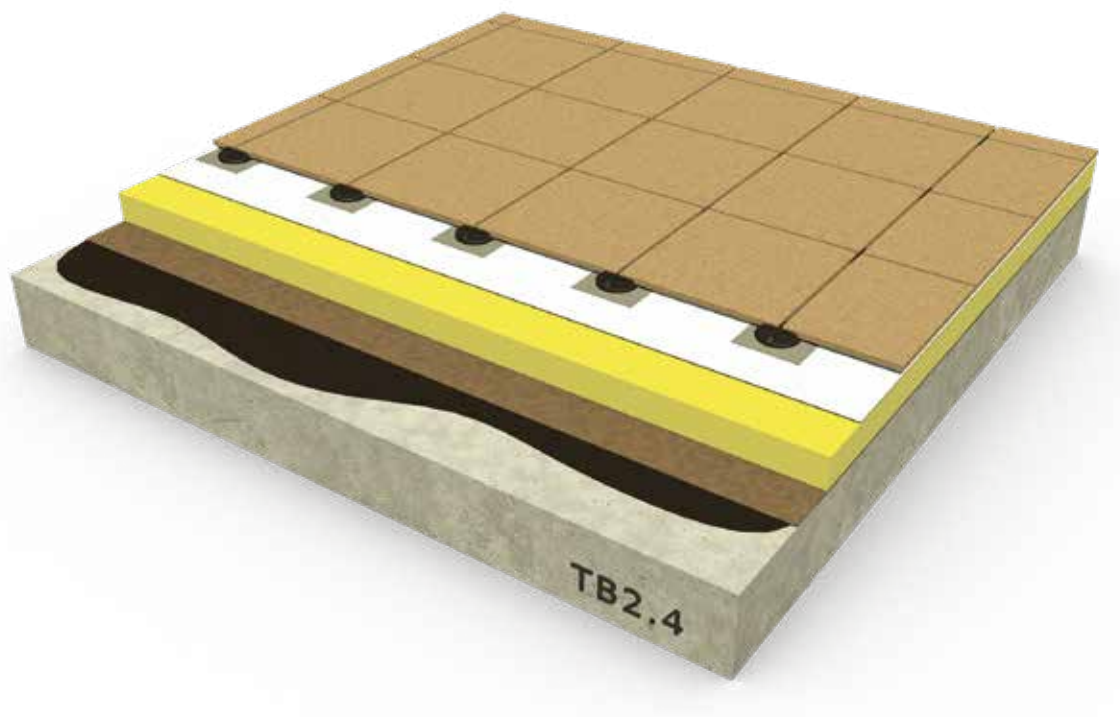

- ① Structure
- ② Vapour barrier layer (e.g. **MAPEPLAN VB PE SD 220** or **IDROPRIMER + POLYVAP**)
- ③ Thermal insulation layer
- ④ **MAPEPLAN T B** waterproofing membrane
- ⑤ **MAPEPLAN T** protection patch
- ⑥ Ballast layer - Floating pavement

BUILD-UP T B3.0

MAPEPLAN T B membrane - Non-insulated pedestrian roof with tile flooring

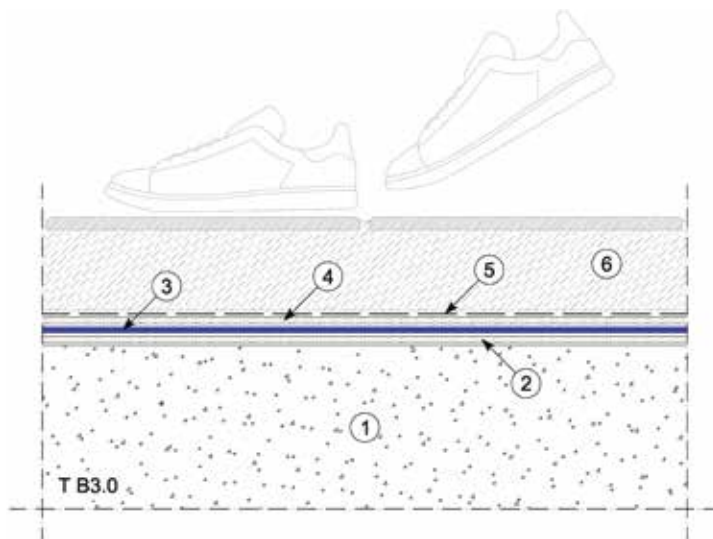
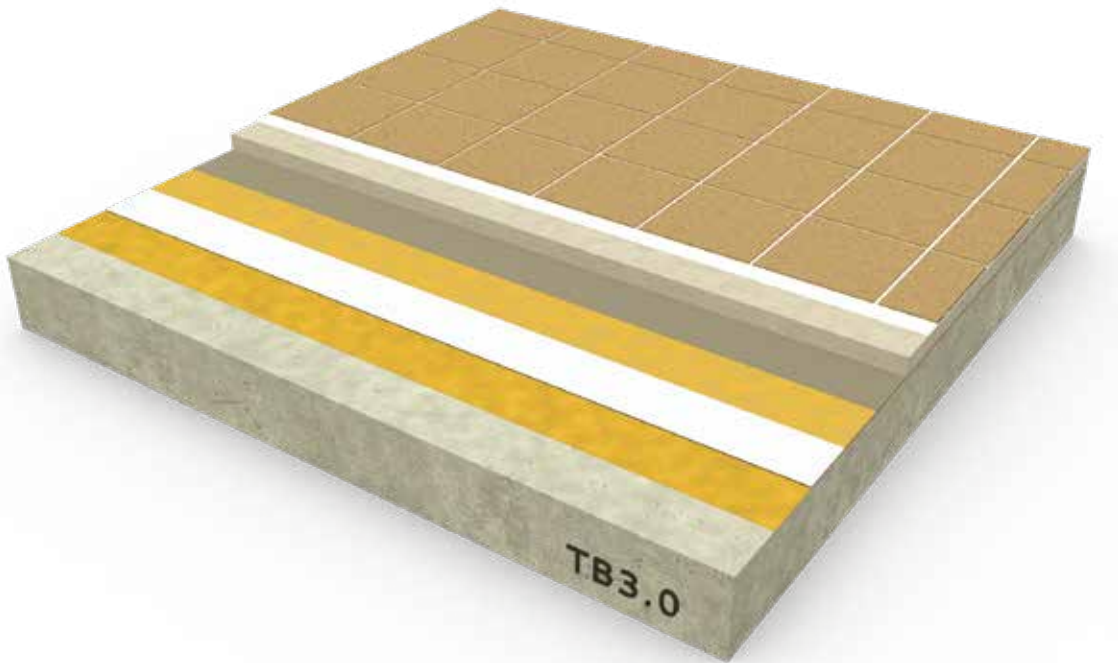

- ① Structure
- ② **POLYDREN PP** levelling layer
- ③ **MAPEPLAN T B** waterproofing layer
- ④ **POLYDREN PP** protection layer
- ⑤ **MAPEPLAN PE micro-perforated** separation and anti-soaking layer
- ⑥ Pedestrian layer - Tile flooring on concrete screed

BUILD-UP T B3.1

MAPEPLAN T B membrane - Insulated pedestrian roof with tile flooring

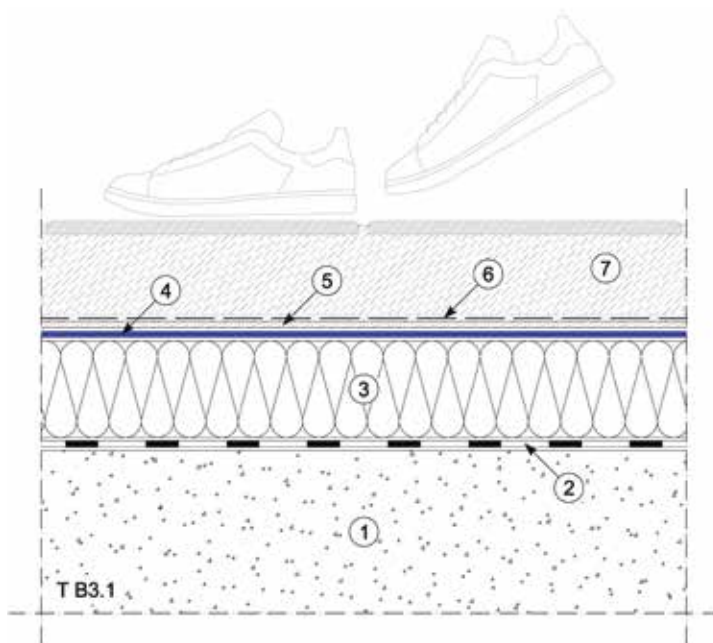
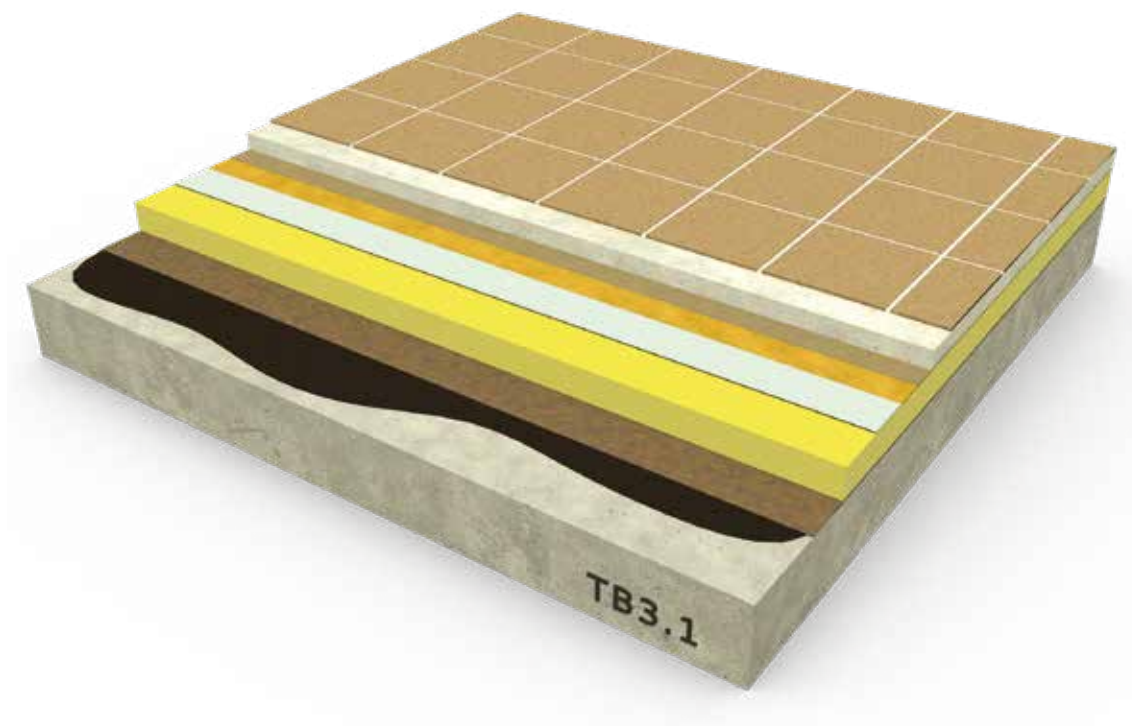

- ① Structure
- ② Vapour barrier layer (e.g. **MAPEPLAN VB PE SD 220** or **IDROPRIMER + POLYVAP**)
- ③ Thermal insulation layer
- ④ **MAPEPLAN T B** waterproofing layer
- ⑤ **POLYDREN PP** protection layer
- ⑥ **MAPEPLAN PE micro-perforated** separation and anti-soaking layer
- ⑦ Pedestrian layer – Tile flooring on concrete screed

BUILD-UP T B3.2

MAPEPLAN T B membrane - Inverted roof pedestrian with tile flooring

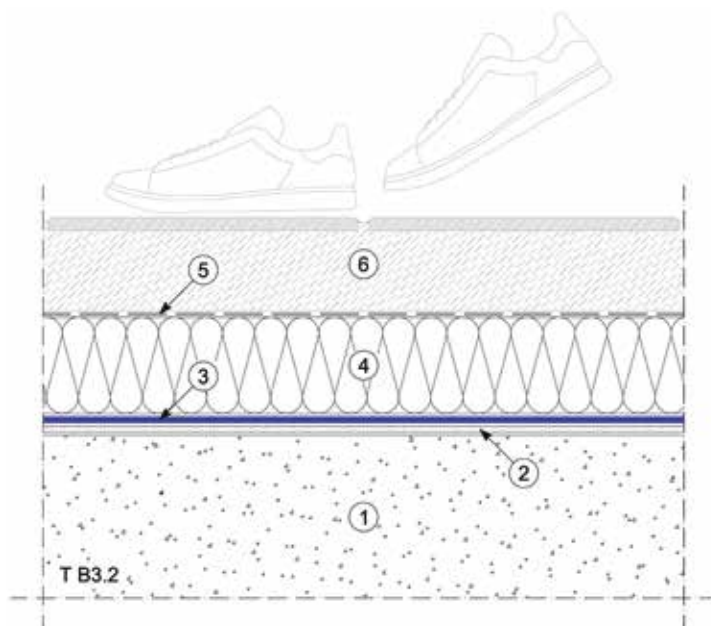
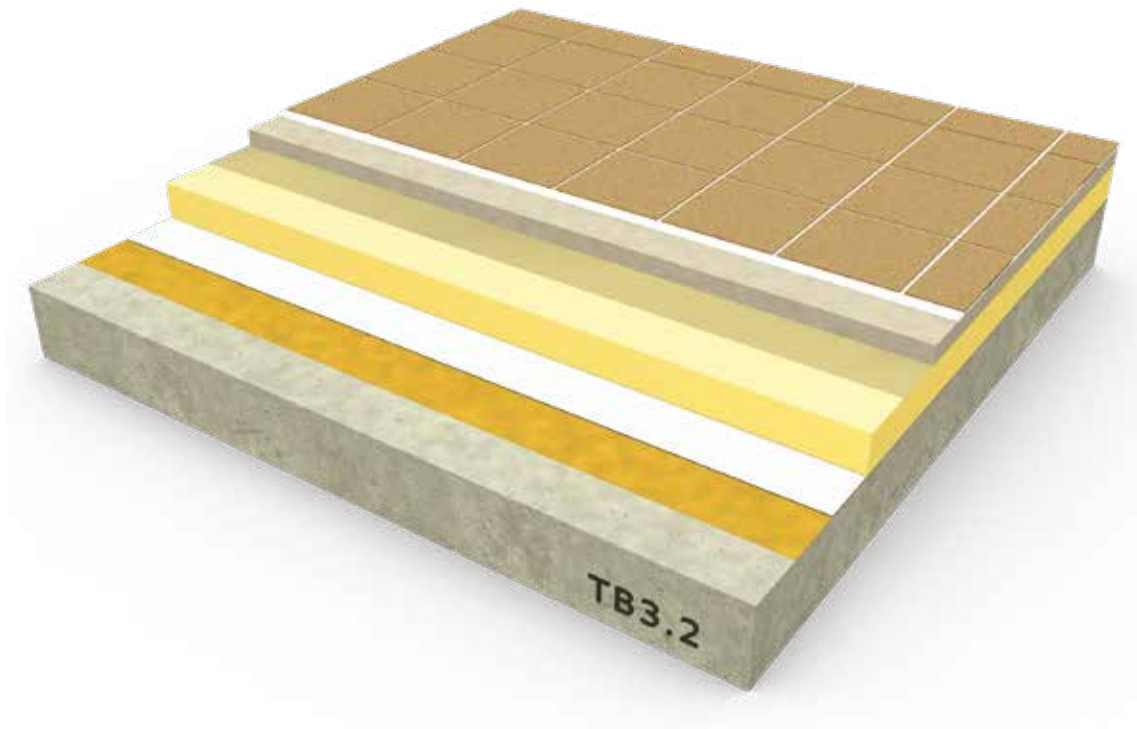

- ① Structure
- ② **POLYDREN PP** levelling layer
- ③ **MAPEPLAN T B** waterproofing membrane
- ④ Thermal insulation layer XPS
- ⑤ **MAPEPLAN PE micro-perforated** separation and anti-soaking layer
- ⑥ Pedestrian layer – Tile flooring on concrete screed

BUILD-UP T B4.0

MAPEPLAN T B membrane - Non-insulated roof with concrete screed and asphalt surface course for vehicle traffic

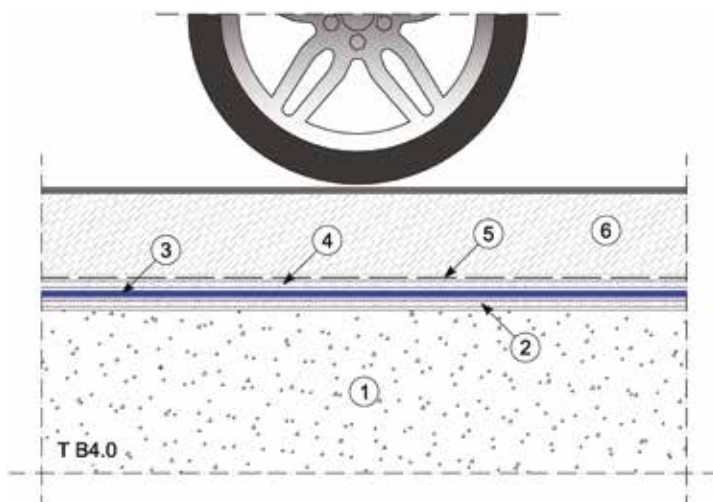
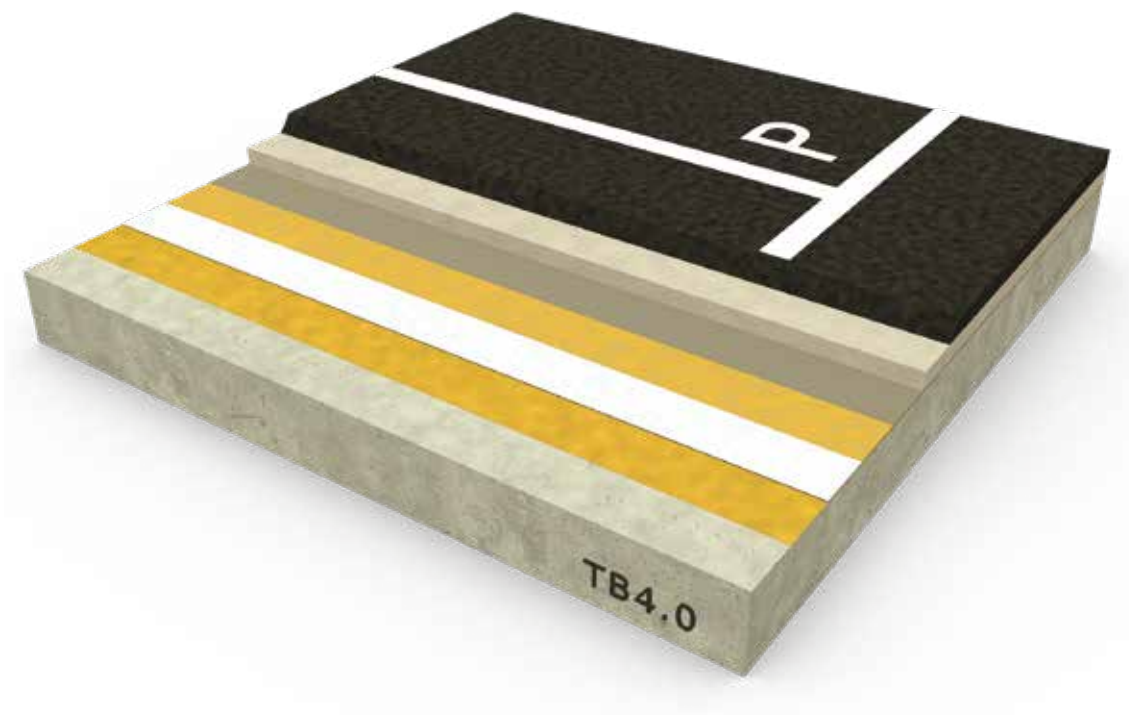

- ① Structure
- ② **POLYDREN PP** levelling layer
- ③ **MAPEPLAN T B** waterproofing membrane
- ④ **POLYDREN PP** protection layer
- ⑤ **MAPEPLAN PE micro-perforated** separation and anti-soaking layer
- ⑥ Vehicle accessible layer - Concrete screed with asphalt surface course

BUILD-UP T B4.1

MAPEPLAN T B membrane - Insulated roof with concrete screed and asphalt surface course for vehicle traffic

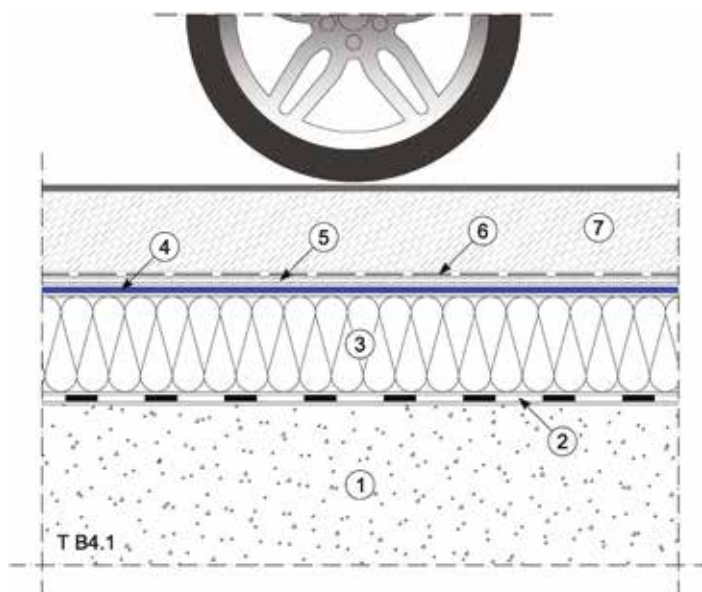
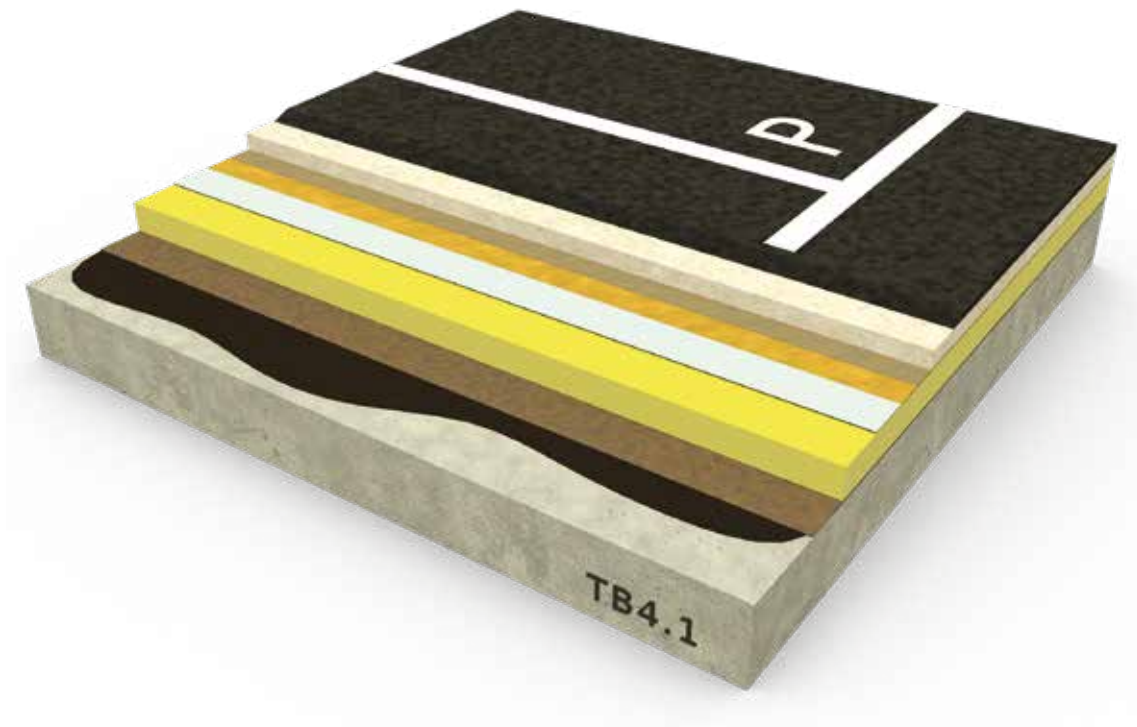

- ① Structure
- ② Vapour barrier layer (e.g. **MAPEPLAN VB PE SD 220** or **IDROPRIMER + POLYVAP**)
- ③ Thermal insulation layer
- ④ **MAPEPLAN T B** waterproofing membrane
- ⑤ **POLYDREN PP** protection layer
- ⑥ **MAPEPLAN PE micro-perforated** separation and anti-soaking layer
- ⑦ Vehicle accessible layer - Concrete screed with asphalt surface course

BUILD-UP T B4.2

MAPEPLAN T B membrane - Inverted roof with concrete screed and asphalt surface course for vehicle traffic

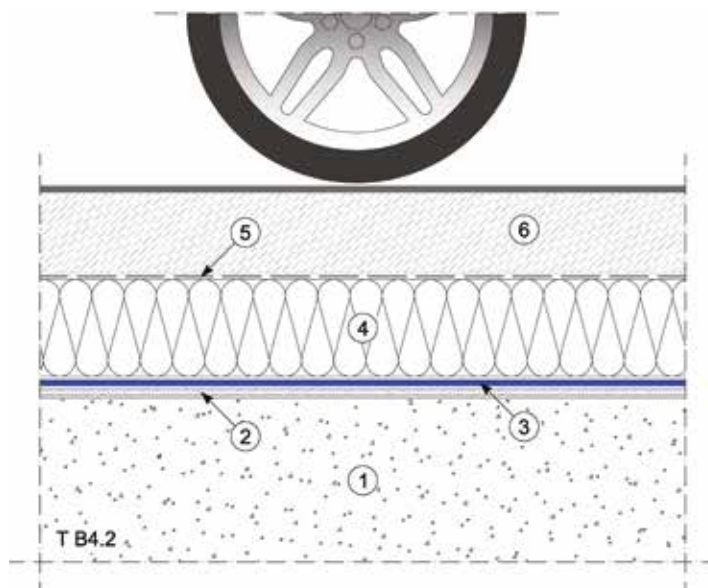
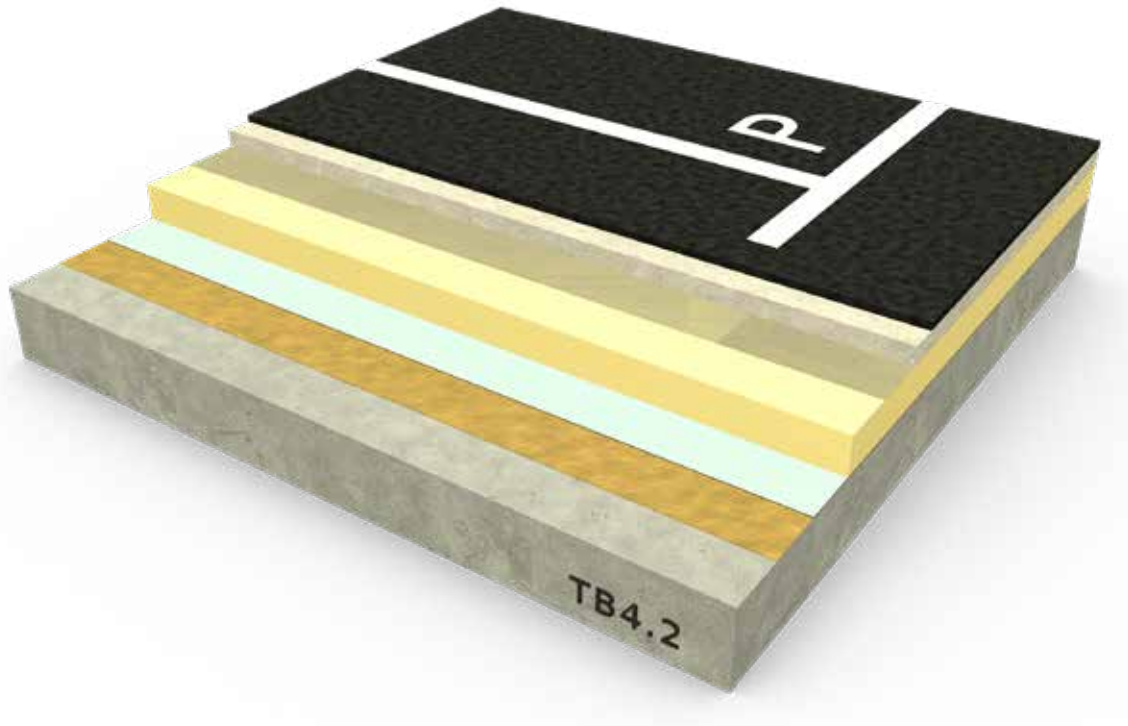

- ① Structure
- ② **POLYDREN PP** levelling layer
- ③ **MAPEPLAN T B** waterproofing membrane
- ④ Thermal insulation layer XPS
- ⑤ **MAPEPLAN PE micro-perforated** separation and anti-soaking layer
- ⑥ Vehicle accessible layer - Concrete screed with asphalt surface course

BUILD-UP T B4.3

MAPEPLAN T B membrane – Non-insulated roof with paving stone on sand for vehicle traffic

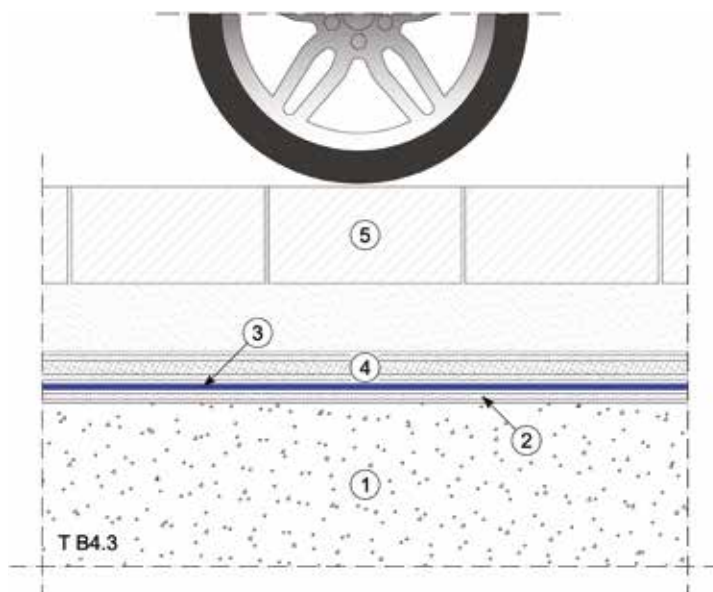
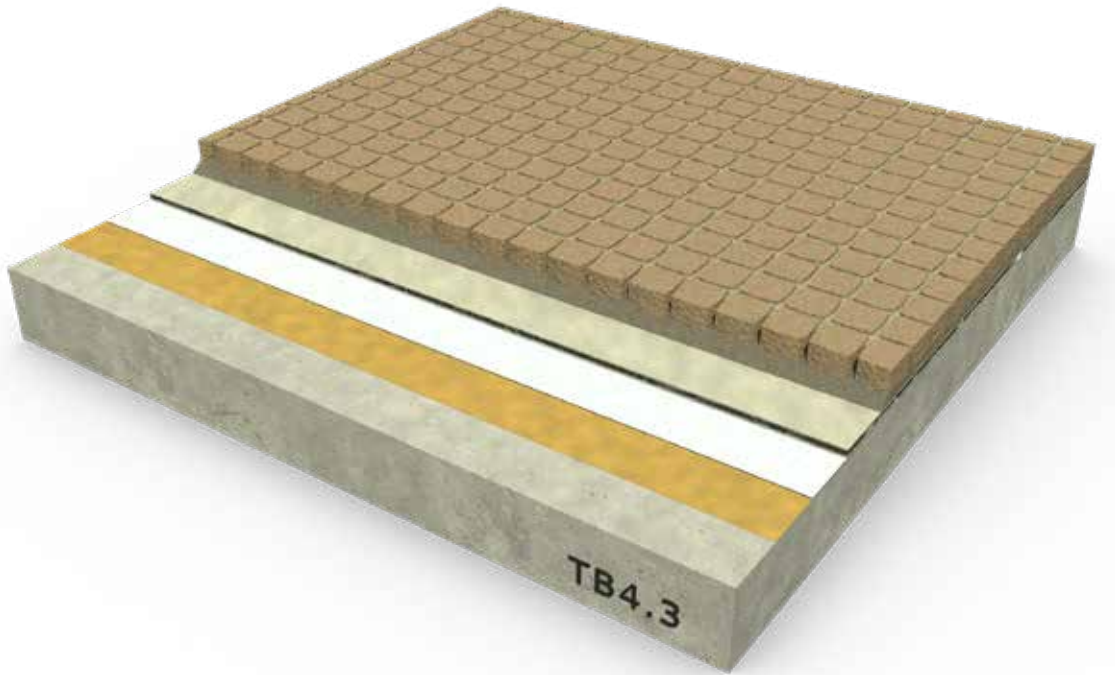

- ① Structure
- ② **POLYDREN PP** levelling layer
- ③ **MAPEPLAN T B** waterproofing membrane
- ④ Drainage and protection layer - Drainage geo-composite
- ⑤ Vehicle accessible layer - Paving stone on sand

**WATERPROOFING SYSTEM
FOR BALLASTED ROOF
MAPEPLAN T B**



5. MAPEPLAN T B solutions - Refurbishment

MAPEPLAN T B waterproofing membranes can be used to design and carry out cost-effective and functional waterproofing refurbishment jobs on existing roofs, with the added option of incorporating additional thermal insulation to improve the building energy efficiency.

But first, it is worth noting that there are two kinds of approach when refurbishing a roof and/or reroofing:

- **Total reroofing**, which consists in stripping back the layers of the existing roof build-up to expose the supporting structure. In this case, the new roof system counts as a new build, hence all the information given so far applies for this type of job, so please refer to the previous chapter 4.
- **Over-roofing**, which consists in leaving the existing build-up system in place and applying the new waterproofing build-up on top, possibly incorporating thermal insulation, where required.

This chapter will cover the latter approach, “over-roofing”, which can be performed over existing bituminous, synthetic, resin or concrete-based waterproofing systems.

Key to the success of any refurbishment is to first determine the origin of the existing issues, only then can they be remedied properly and permanently.

Comprehensive information is required to understand the issues and all essential data must be procured in order to come up with the correct technical solution, both by checking the documents for the existing roof (invoices, as-built drawings, specifications, etc.) and by conducting on-site surveys.

Document checks can provide us with important preliminary information, which will then be verified with inspections and surveys performed on site.

On-site inspections and surveys - possibly involving taking core samples - are useful and necessary in order to gather information on the composition and condition of the existing roof build-up and on whether or not the roof is affected by surface or interstitial condensation.

A hygrothermal analysis can help determine whether condensation can form and hence whether action may be required, namely applying a vapor barrier or vapor control layer, and/or whether a new thermal insulation layer should be applied or the existing one upgraded, in which case the insulation will need to be checked for moisture and assessed to determine its compressive strength.

You will need to inspect the existing waterproofing layer, any protuberances, creases, unevenness or blistering must be removed in order to produce as level a substrate as possible. If no new thermal insulation layer is due to be applied, the substrate will nonetheless be covered with a geotextile levelling and regulating layer (POLYDREN PP) of a suitable thickness and weight before the new MAPEPLAN T B waterproofing membrane is laid on top.

In case of refurbishment of a ballasted roof system with gravel or floating pavements, usually the ballast layer is already there; in this case it is more convenient to reuse the exiting ballast layer. The ballast is partially moved in a different roof area, thus without the need of removing it from the roof.

In the case of refurbishment of a ballasted roof system with tile paving or parking deck, if the condition allows it (overloads available, integrity, surface cohesion and regularity of existing paving, height of vertical parts and height of threshold step), it is more convenient to keep the existing pavements, over-lay the new waterproofing membrane MAPEPLAN T B and place a new paving on top.

The minimum requirements for the successful installation of a functional and long-lasting over-roof system are:

- Substrate to have a smooth and even surface.
- Substrate to have suitable compressive strength and withstand foot traffic.
- Correct build-up based on temperature and humidity conditions.
- Supporting structure to be suitable for ballasted system.
- Water to run off correctly and suitable and functional slopes.
- Possibility to lifting and/or connection to rooftop building services, if any.

MAPEPLAN T B membrane - Over-roofing refurbishment without additional thermal insulation layer

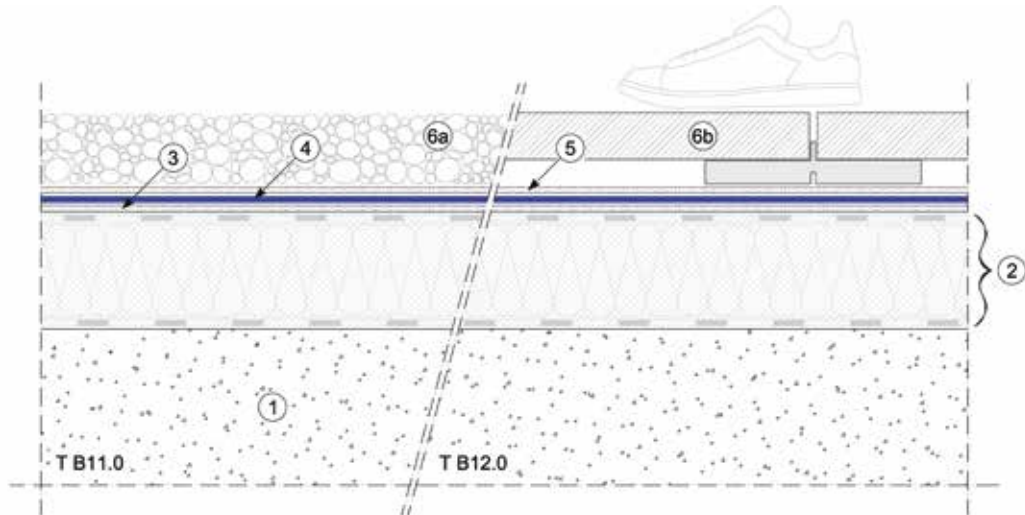

- ① Structure
- ② Existing waterproofing build-up
- ③ POLYDREN PP separating layer
- ④ MAPEPLAN T B waterproofing membrane

- ⑤ POLYDREN PP protection layer
- ⑥a Ballast layer - Gravel
- ⑥b Ballast layer - Floating pavement

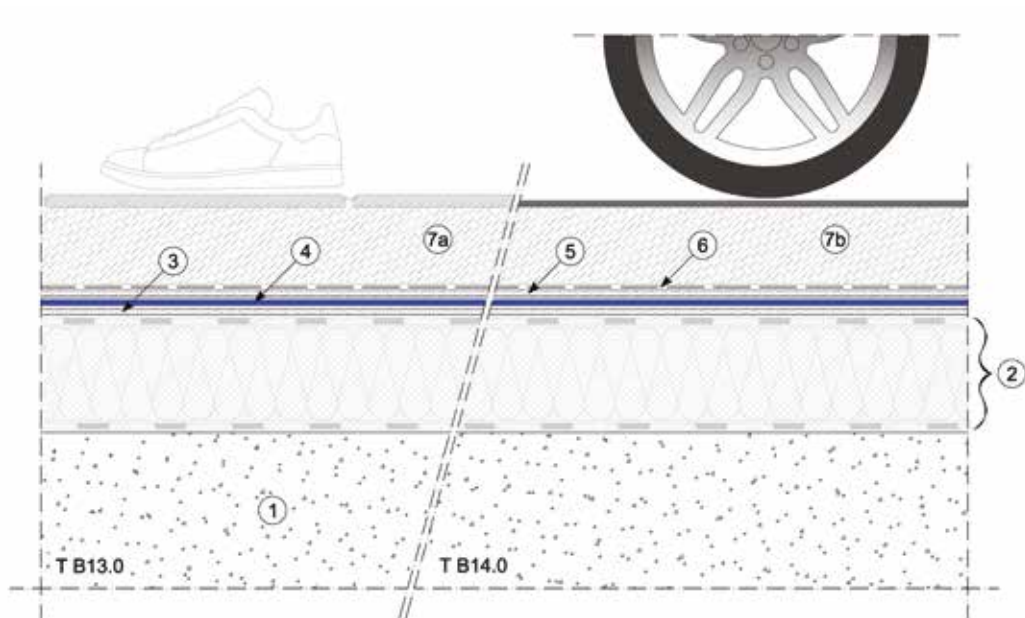

- ① Structure
- ② Existing waterproofing build-up
- ③ POLYDREN PP separating layer
- ④ MAPEPLAN T B waterproofing membrane

- ⑤ POLYDREN PP protection layer
- ⑥ MAPEPLAN PE micro-perforated separation and antisoaking layer
- ⑦a Pedestrian layer - Tile flooring on concrete screed
- ⑦b Vehicle accessible layer - Concrete screed with asphalt surface course

MAPEPLAN T B membrane - Over-roofing refurbishment with additional thermal insulation layer

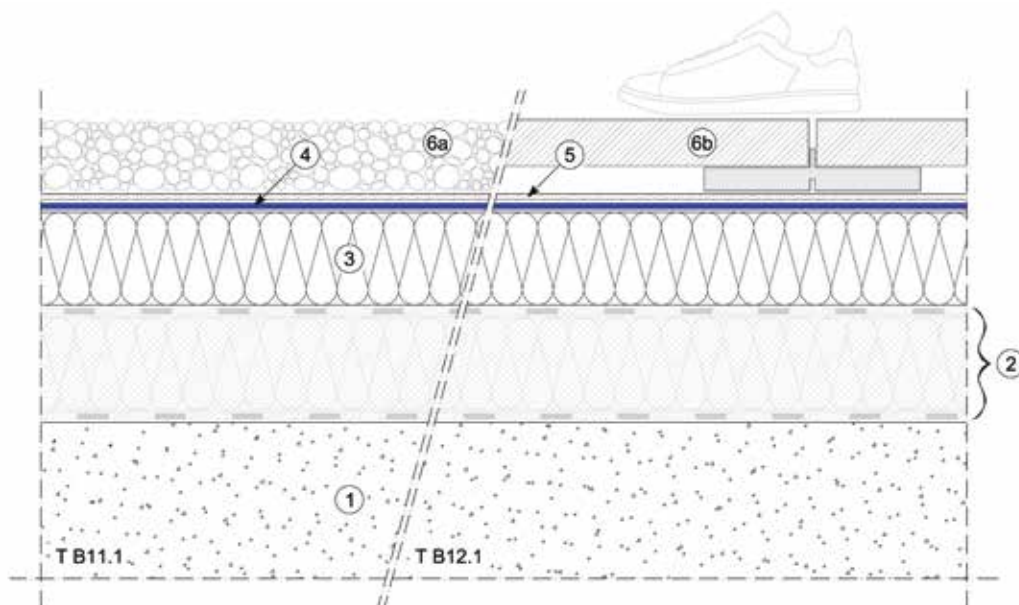

- ① Structure
- ② Existing waterproofing build-up
- ③ Thermal insulation layer
- ④ **MAPEPLAN T B** waterproofing membrane

- ⑤ **POLYDREN PP** protection layer
- ⑥a Ballast layer - Gravel
- ⑥b Ballast layer - Floating pavement

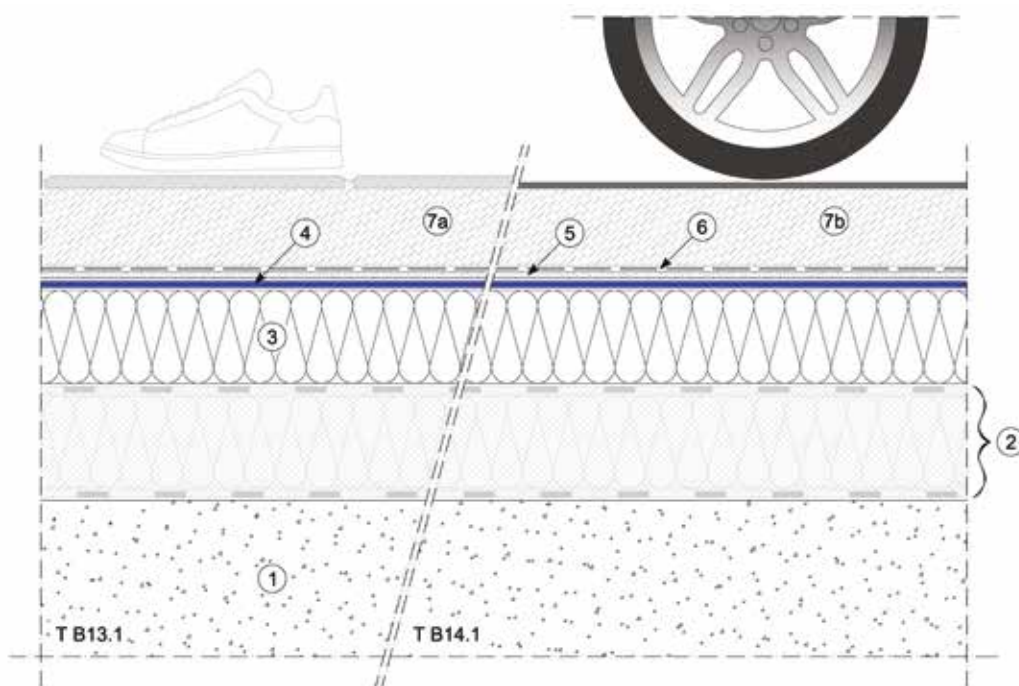

- ① Structure
- ② Existing waterproofing build-up
- ③ Thermal insulation layer
- ④ **MAPEPLAN T B** waterproofing membrane

- ⑤ **POLYDREN PP** protection layer
- ⑥ **MAPEPLAN PE micro-perforated** separation and antisoaking layer
- ⑦a Pedestrian layer - Tile flooring on concrete screed
- ⑦b Vehicle accessible layer - Concrete screed with asphalt surface course

MAPEPLAN T B membrane - Over-roofing refurbishment with additional thermal insulation layer

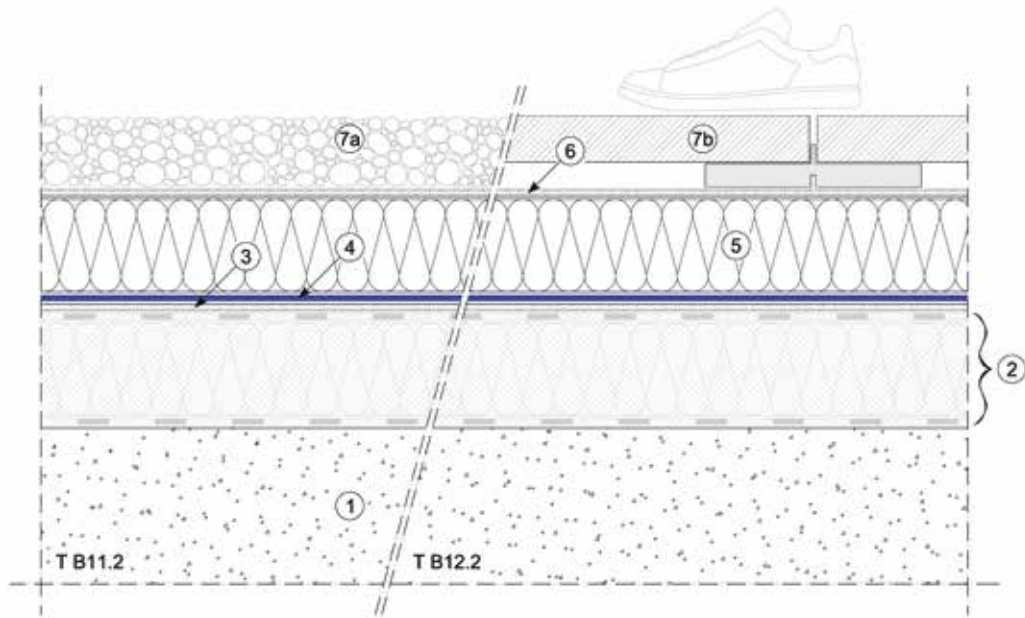

- ① Structure
- ② Existing waterproofing build-up
- ③ POLYDREN PP separating layer
- ④ MAPEPLAN T B waterproofing membrane

- ⑤ Thermal insulation layer XPS
- ⑥ POLYDREN PP filter layer
- ⑦a Ballast layer - Gravel
- ⑦b Ballast layer - Floating pavement

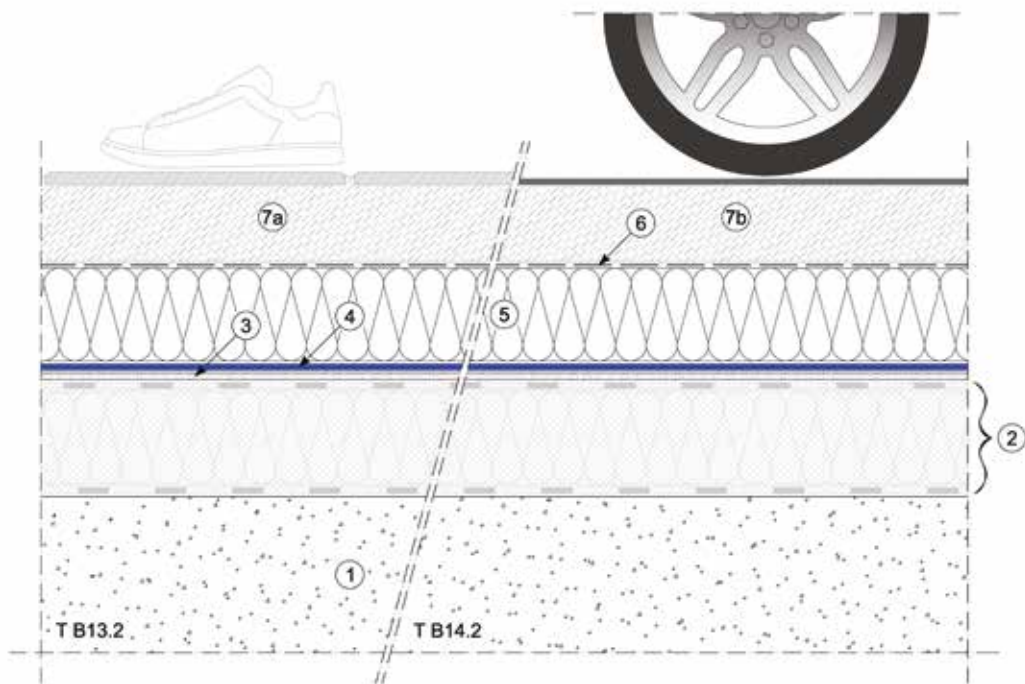

- ① Structure
- ② Existing waterproofing build-up
- ③ POLYDREN PP separating layer
- ④ MAPEPLAN T B waterproofing membrane

- ⑤ Thermal insulation layer XPS
- ⑥ MAPEPLAN PE micro-perforated separation and anti-soaking layer
- ⑦a Pedestrian layer – Tile flooring on concrete screed
- ⑦b Vehicle accessible layer - Concrete screed with asphalt surface course

MAPEPLAN T B membrane - Over-roofing refurbishment on concrete screed, existing waterproofing build-up without thermal insulation layer

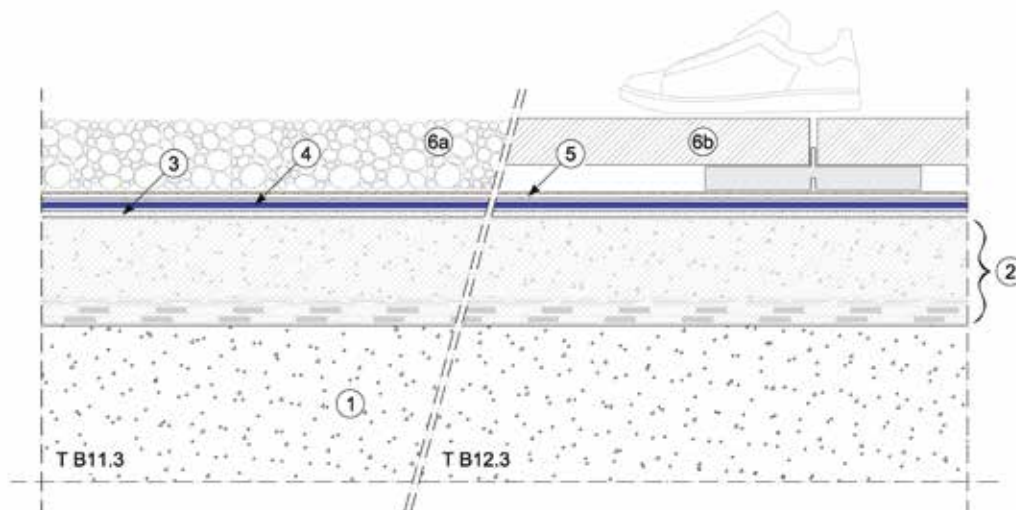

- ① Structure
- ② Existing waterproofing build-up
- ③ **POLYDREN PP** separating layer
- ④ **MAPEPLAN T B** waterproofing membrane

- ⑤ **POLYDREN PP** protection layer
- ⑥a Ballast layer - Gravel
- ⑥b Ballast layer - Floating pavement

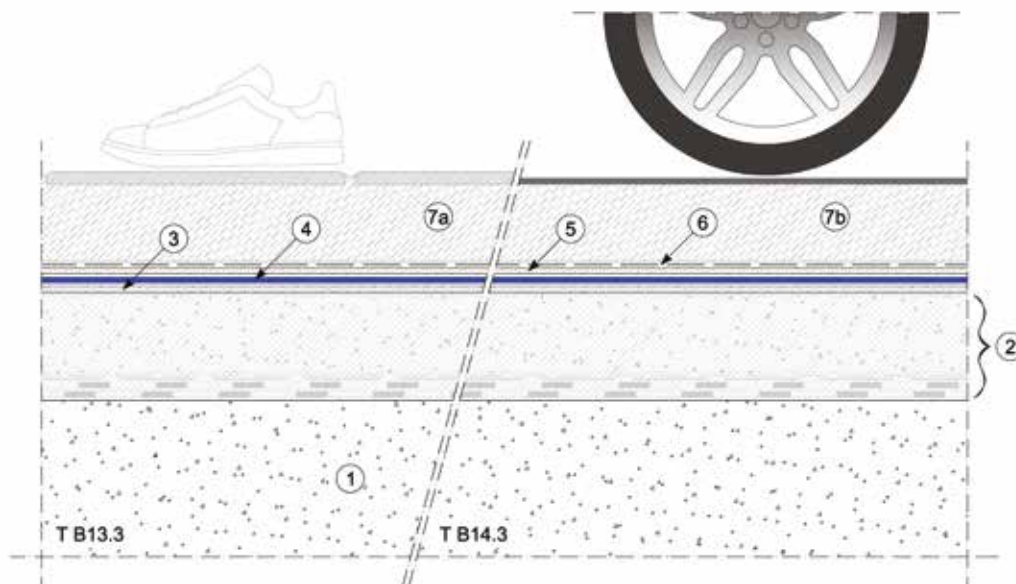

- ① Structure
- ② Existing waterproofing build-up
- ③ **POLYDREN PP** separating layer
- ④ **MAPEPLAN T B** waterproofing membrane

- ⑤ **POLYDREN PP** protection layer
- ⑥ **MAPEPLAN PE micro-perforated** separation and anti-soaking layer
- ⑦a Pedestrian layer - Tile flooring on concrete screed
- ⑦b Vehicle accessible layer - Concrete screed with asphalt surface course

MAPEPLAN T B membrane - Over-roofing refurbishment on concrete screed, existing waterproofing build-up with thermal insulation layer

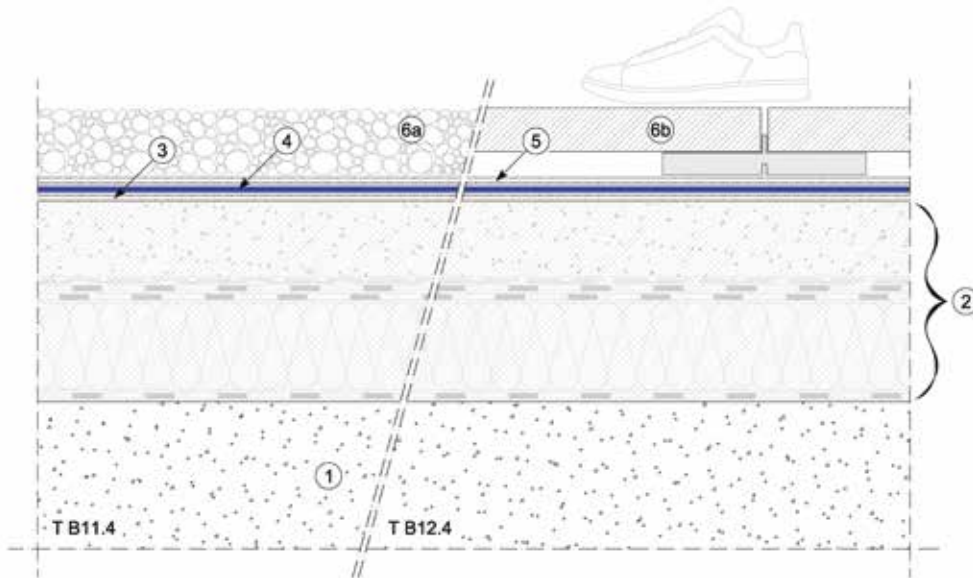

- ① Structure
- ② Existing waterproofing build-up
- ③ POLYDREN PP separating layer
- ④ MAPEPLAN T B waterproofing membrane

- ⑤ POLYDREN PP protection layer
- ⑥a Ballast layer - Gravel
- ⑥b Ballast layer – Floating pavement

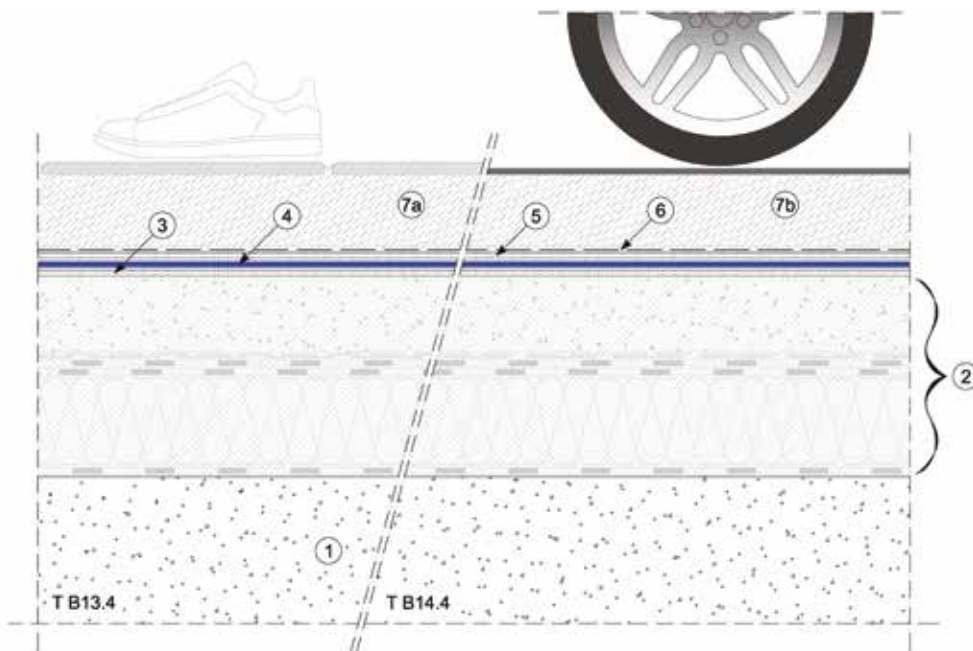

- ① Structure
- ② Existing waterproofing build-up
- ③ POLYDREN PP separating layer
- ④ MAPEPLAN T B waterproofing membrane

- ⑤ POLYDREN PP protection layer
- ⑥ MAPEPLAN PE micro-perforated separation and anti-soaking layer
- ⑦a Pedestrian layer - Tile flooring on concrete screed
- ⑦b Vehicle accessible layer - Concrete screed with asphalt surface course

Daily provisional waterproofing sealing

The daily provisional waterproofing sealing avoids the risk of water getting inside accidentally while the job is in progress as the roof watertight is ensured at every stage of the project. When dealing with MAPEPLAN T B FPO/TPO flexible polyolefin synthetic membranes, rational and functional sealing can be done in any situation likely to be encountered. By way of a guide, a few possible solutions are given below.

Daily sealing by welding together MAPEPLAN T B and existing FPO/TPO waterproofing membrane - Thermal welding

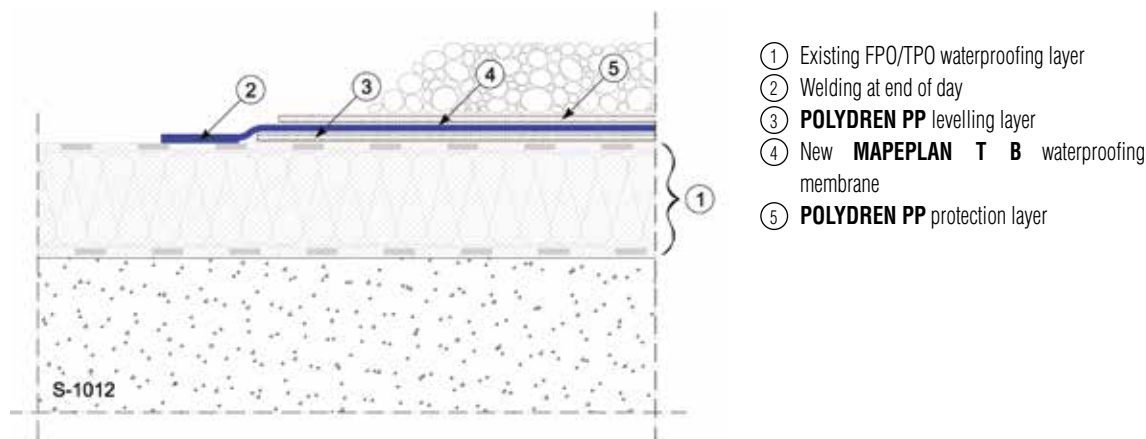

Daily sealing by taping together MAPEPLAN T B and existing PVC-P or FPO/TPO waterproofing membrane - BUTYLSTRIP tape

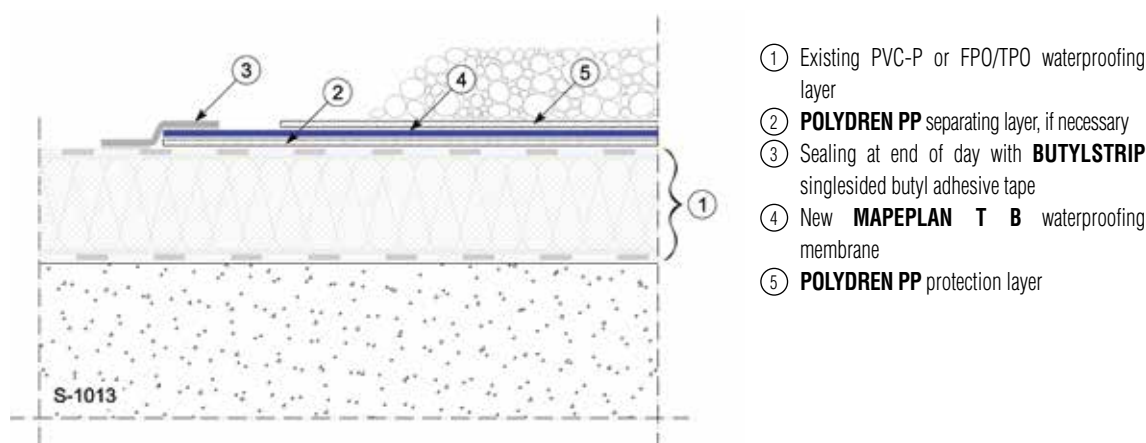

NOTE:

These connections should be considered temporary to stop water ingress while work is in progress.

Daily sealing between MAPEPLAN T B and existing polymer bitumen waterproofing membrane

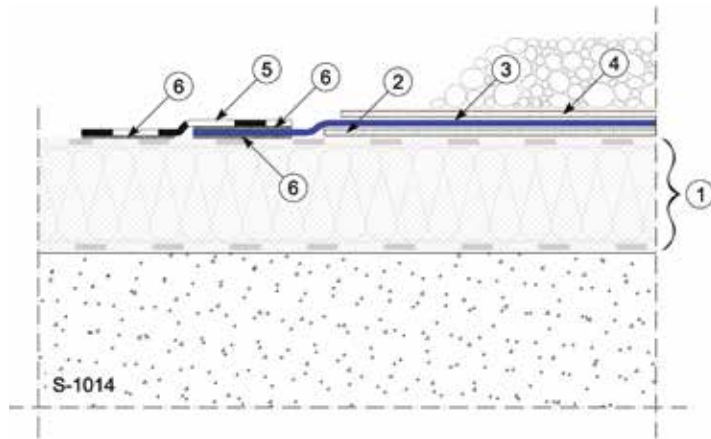

- ① Existing bituminous waterproofing layer
- ② **POLYDREN PP** separating layer, if necessary
- ③ New **MAPEPLAN T B** waterproofing membrane
- ④ **POLYDREN PP** protection layer
- ⑤ Sealing with strip of elastomeric bituminous membrane
- ⑥ Hot-air welding

Daily sealing between MAPEPLAN T B and existing waterproofing layer on build-up incorporating thermal insulation

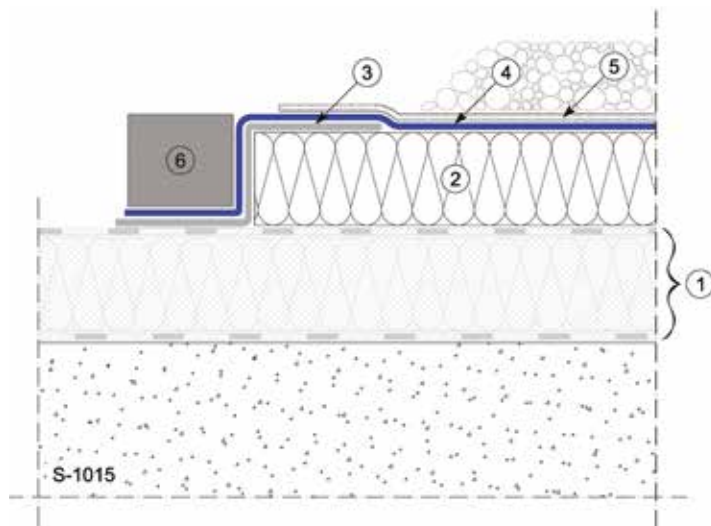

- ① Existing waterproofing layer
- ② New supplementary thermal insulation layer
- ③ Sealing at end of day with strip of material compatible with existing waterproofing layer
- ④ New **MAPEPLAN T B** waterproofing membrane
- ⑤ **POLYDREN PP** protection layer
- ⑥ Removable ballast

NOTE:

These connections should be considered temporary to stop water ingress while work is in progress.

6. Basic requirements of synthetic waterproofing membranes for ballasted roof, pedestrian roof and parking deck

As mentioned earlier in the foreword, the waterproofing system of a ballasted roof, pedestrian roof and parking deck, is a key factor in producing a roof that is built properly and will have a long service life. More specifically, the synthetic waterproofing membrane must meet specific basic requirements, which are key to ensuring adequate and necessary performance. MAPEPLAN T B waterproofing membranes meet all the requirements given below.

To be fit for use on ballasted roofs, the synthetic waterproofing membrane must:

- Meet the requirements, points and conditions listed in standard EN 13956, according to the relevant tests described, in order for the membrane to earn the certificate of conformity with harmonized European standards and hence CE marking. Specific reference standard: *standard EN 13956 - Flexible sheets for waterproofing - Plastic and rubber sheets for roof waterproofing - Definitions and characteristics.*
- Be waterproof and withstand the pressure of the water. Specific reference standard: *Determination of watertightness test according to standard EN 1928.*
- Feature great dimensional stability and have a low coefficient of thermal expansion. This trait is essential when the waterproofing membrane is being applied: the membrane can actually be exposed to high temperatures and considerable changes in temperature between being laid and the ballasted roof being built on top. During this stage, the membrane must not move from its original position, thus minimizing the risk of mechanical damage. This trait is also important during its service life as an unstable material will be subjected to strain at the fixed points, with the result that the membrane may be damaged or tear. Only a membrane with an internal glass mat reinforcement can guarantee this kind of performance. Specific reference standard: *Determination of dimensional stability test according to standard EN 1107-2.*
- Have high mechanical strength. The waterproofing membrane must be able to withstand, with a sufficient safety margin, the anticipated permanent and accidental loads and accidental impact and damage that might occur during the roof's construction and service. Specific reference standards: *Determination of resistance to static loading test according to EN 12730 and Determination of resistance to impact test according to standard EN 12691.*

- Have excellent foldability at low temperatures as this indicates that the synthetic membrane is good quality. Specific reference standard: *Determination of foldability at low temperature test according to standard EN 495-5.*
- Be resistant to ageing and durable, ensuring the waterproofing system offers decades of service. Especially given that repairing/refurbishing the waterproofing system is a very costly operation as it involves removing and disposing of the ballast layer on top. Specific reference standard: *Artificial ageing by long-term exposure to the combination of UV radiation, elevated temperature and water test according to standard EN 1297 and Screening test method for determining the resistance to oxidation according to standard EN 14575.*
- Be easy to work with and weld so that even the most complex shapes and complicated features on the roof can be covered securely. Specific reference standards: *Determination of peel resistance of joints test according to standard EN 12316-2 and Determination of shear resistance of joints test according to standard EN 12317-2.*
- Be resistant to microorganisms and any leachate they might come into contact with. Specific reference standards: *Method for determining the microbiological resistance by a soil burial test according to standard EN 12225 and Test method for determining the resistance to leaching according to standard EN 14415.*
- Be resistant to root penetration. Roots must not pierce the waterproofing membrane either on the continuous surface or at any point along the main seams or secondary seams. Specific reference standards: *Determination of resistance to root penetration test according to standard EN 13948 and the even stricter FLL test (Forschungsgesellschaft Landschaftsentwicklung Landschaftsbau e.V.).*
- Be UV stable, resistant to ageing and weather, when the membrane is leave exposed, as for example on vertical surface. Specific reference standard: *Method of Artificial ageing by long-term exposure to the combination of UV radiation, elevated temperature and water test according to standard EN 1297.*

7. MAPEPLAN T B waterproofing membranes

The MAPEPLAN T B waterproofing system comprises the FPO/TPO flexible polyolefin waterproofing membrane, which offers UV stability and weathering resistance and has a high dimensional stability internal glass mat reinforcement. The membrane is specifically designed and produced for loose-laid and subsequently ballasted systems (pedestrian roofs, parking deck, green roofs).

The ballasted layer could be made with gravel, floating pavement (square stone on supports), pavement cast on site (concrete screed), pavement for vehicle traffic (concrete screed with asphalt surface course, paving stone on sand), green roof (extensive and intensive).

Features and advantages of the MAPEPLAN T B system

The special features of the waterproofing membrane MAPEPLAN T B are summarized below.

INTERNAL FLEXIBILITY

Innovative waterproofing membrane formulated without plasticizers or volatile substances.

The membrane gets its flexibility from the special chemical structure of its polymer component: the element that renders it so flexible is found in the molecular chain and is “chemically bonded” to it. This chemical bond is very strong and difficult to separate, which essentially results in the membrane inherent qualities lasting longer, in greater resistance to aggressive substances, as well as improved weathering resistance and resistance to microorganisms and bacteria.

DIMENSIONAL STABILITY

Dimensional stability is assured by the internal glass mat reinforcement and by the “multi-extrusion coating” production process.

Internal glass mat reinforcement with great dimensional stability and low coefficient of linear thermal expansion, which ensure minimal movement as a result of changes in temperature (day/night, summer/winter). This is an essential quality in systems with loose-laid membranes, both during the initial installation stage and when it is in service.

MICROORGANISMS RESISTANCE

The waterproofing membrane MAPEPLAN T B is totally resistant to microorganisms because is not made with plasticizers and volatile substances. Specific reference standard: *Method for determining the microbiological resistance by a soil burial test according to standard EN 12225*. For this reason MAPEPLAN T B is especially indicated for application into ballasted system with gravel or floating pavements where the microorganisms and bacteria growth condition are more favorable.



CHEMICAL AND LEACHING RESISTANCE

The waterproofing membrane MAPEPLAN T B has high resistance to chemical substances and leaching because it is not made with plasticizers and volatile substances. Specific reference standard: *Test method for determining the resistance to leaching according to standard EN 14415*. This standard defines a method for testing the behavior in hot water, aqueous alkaline liquids and organic alcohols. This type of membrane is also used and certified to waterproof containment tanks and for the security storage of aggressive and polluting substances.

RESISTANCE TO ROOT PENETRATION - FLL TEST



The MAPEPLAN T B waterproofing membrane is completely resistant to penetration by roots and rhizomes, as required by the strictest FLL test conducted over a period of two years, and also meets the requirements of standard EN 13948. Resistance to root penetration is one of the product's inherent properties and is not achieved with the addition of volatile substances or additives likely to wash off. The hot air welding of the overlaps and details ensure the resistance to root penetration.

DURABILITY

The MAPEPLAN T B waterproofing membrane have a higher durability. In fact, accelerated ageing tests confirm many decades of service.

These values are also confirmed by numerous tests carried out by the producers of the raw material (flexible polyolefin). Flexible polyolefin membranes have been applied worldwide for decades with excellent results. To draw a comparison that everyone can understand, let's take those plastic shopping bags (which are also made mostly from polyolefin): the issue with these bags is not durability, on the contrary it's their excellent and long-lasting resistance to chemicals and physical and mechanical strength that are the problem. In the case of shopping bags, these traits are not seen as advantages, while they definitely are for a waterproofing membrane that is instead required to last a long time.

Below is an excerpt from the BBA Technical Agrèment, section 12 - DURABILITY: "Accelerated weathering tests confirm that satisfactory retention of physical properties is achieved. Under normal conditions, the membranes will have a service life in excess of 25 years".

PUNCTURE RESISTANCE

MAPEPLAN T B waterproofing membranes have a higher mechanical resistance to puncture, they resist to designed permanent loads and impact loads, to impact and accidental damages, during the construction and lifetime of the building, with an adequate safety margin. The puncture resistance is related to the thickness of the membrane, the greater the thickness the higher the resistance to puncture, as shown in diagram below.

The values in the diagram are the same indicated in our technical data sheet, and they are according to *EN 12691 Determination of resistance to impact*. This method represents the dynamic category of load where puncture may be caused by impact. The impact is made by a drop mass with a spherical puncturing tool of 12,7 mm diameter and 0,5 kg weight, in free fall. Test passes if after the impact the sample is not perforated, and the water-tightness is guaranteed. The resistance value declared, expressed in millimeters, is the puncturing fall height that does not cause damage or loss of water-tightness. The test is made on two different supports: a rigid support (aluminum sheet) and a soft support (EPS sheet of 150 kPa).

Puncture resistance EN 12691

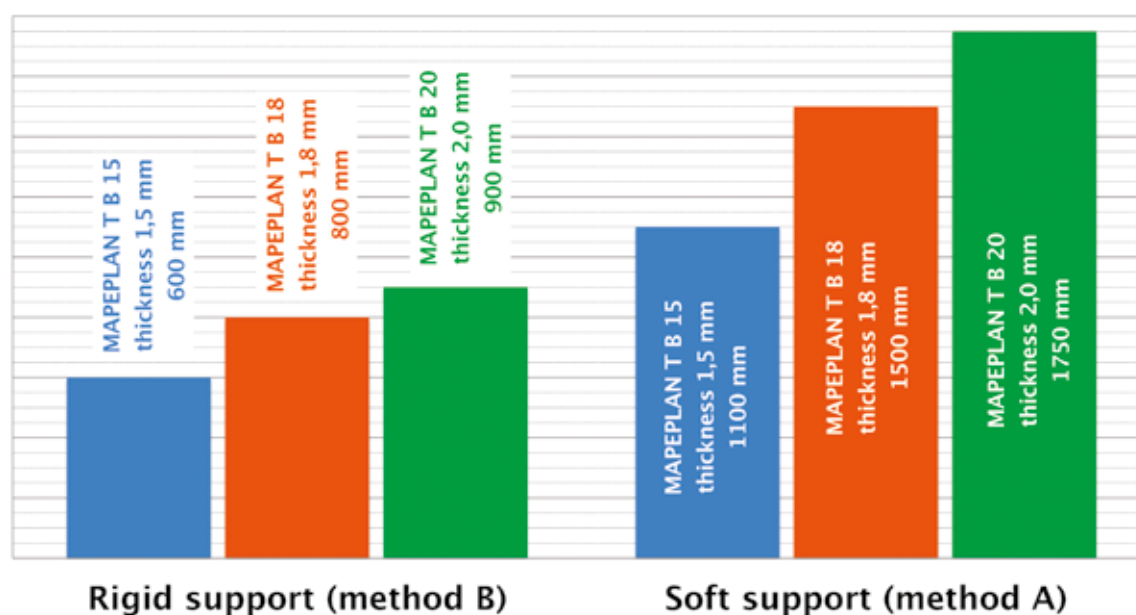

SMART WHITE SURFACE COLOUR

The MAPEPLAN T B waterproofing membrane has a special white top layer, Smart White, which gives the product its excellent solar reflectivity.

MAPEPLAN T B reduces roof surface temperature by over 50% compared to a black/dark-colored roof.

This is an undeniable advantage during the waterproofing membrane's application and the building of the roof as the low surface temperature reduces movements caused by thermal expansion.

The Italian standard UNI 11235 states: "High dimensional stability is essential during the waterproofing

membrane's application. Until the green roof has been laid, the membrane may be exposed to high temperatures when in direct sunlight and is exposed to changes in temperature between day and night. To avoid mechanical damage during this period, the membrane must not move from the position it is originally laid in and must not be strained at fixed points, such as: roof edges, drain outlets, penetrations and protrusions, etc. A highly dimensionally stable membrane minimizes the risk of damage as a result of the above-mentioned movements."

It is also worth remembering that this unique Smart White color runs through the material and is an integral part of it, which is of more benefit than subsequently applied treatments.

The SRI (Solar Reflectance Index) value is 102 according to standard ASTM E1980.

SIGNAL LAYER SURFACE COLOUR

The different color on the membrane's surface also has the advantage of acting as a warning layer, providing visual evidence of any accidental mechanical damage or surface scratching as a result of work carried out once the membrane has been laid.

"MULTI-EXTRUSION COATING" PRODUCTION PROCESS

The MAPEPLAN T B membrane is manufactured in a modern, technologically advanced and environmentally friendly "Multi-extrusion coating" plant.

This production system allows the FPO/TPO synthetic matrix to be applied directly and at the same time to both faces of the carrier in one go, thus ensuring that it is incorporated perfectly in the membrane's structure.

This special process means the MAPEPLAN T B membrane is not prone to delamination problems, instead essentially qualifying as a single-ply membrane that offers good resistance to foreseeable stress (physical, chemical, thermal). MAPEPLAN T B membranes are not produced using pre-laminated sheets that then have to be bonded together.

WELDING BY HEAT FUSION

The MAPEPLAN T B waterproofing membranes are thermoplastic elastomers, which means they have excellent weldability properties and are actually thermal welded with hot air. This welding method effectively fuses together the molecular chains: the welding of MAPEPLAN T B membrane withstand the pressure of the water and are mechanically strong, as highlighted in chart below.

Welding Test - MAPEPLAN T B

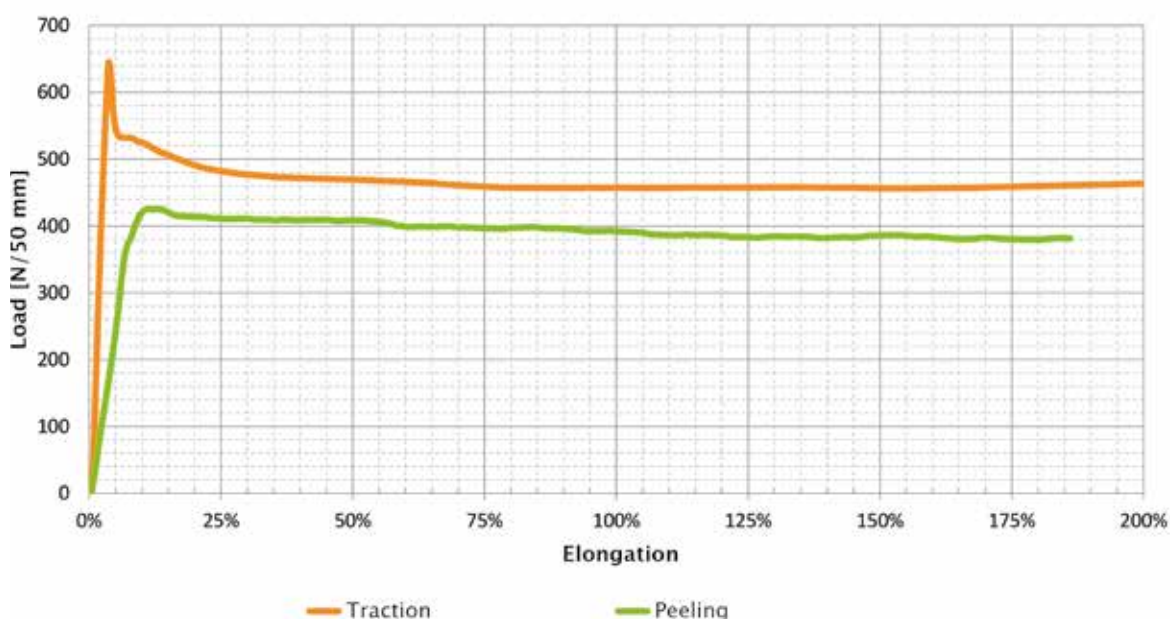

UV RADIATION AGEING TEST

Artificial ageing testing of MAPEPLAN T by long-term exposure to the combination of UV radiation, elevated temperature and moisture, according to standard EN 1297.

UV stability and resistance to ageing are essential requirements for a waterproofing membrane when leaved exposed, for example on vertical surfaces.

Testing conducted by Polyglass laboratory on MAPEPLAN T, according to EN 1297, confirm an excellent UV and aging resistant, much higher to normative minimum value requested.

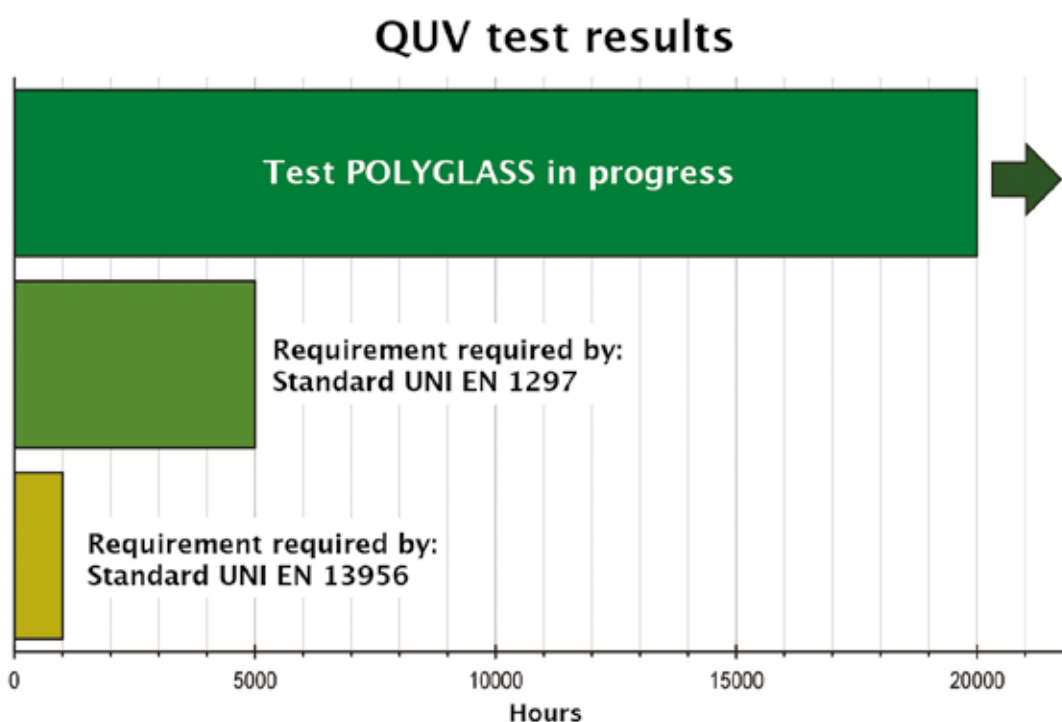

GREEN CREDENTIALS

Being free from plasticizers and volatile substances and containing no substances that are detrimental or harmful to people or the environment, MAPEPLAN T B is a highly eco-friendly product. The modern and technologically advanced production system has been designed and built to deliver the lowest possible environmental impact.

This low environmental impact is guaranteed during all stages of the membrane life cycle: manufacture, transport, installation, service life, end-of-life disposal. Once the waterproofing membrane reaches the end of its life cycle, it can be removed and recycled/reused to produce new raw material.

EPD - Environmental Product Declaration



MAPEPLAN T B waterproofing membranes come with an EPD (Environmental Product Declaration).

The EPD is defined by standard ISO 14025 as a document containing quantified environmental data for a product with preset categories of parameters calculated using the Life Cycle Assessment (LCA) method and hence based on the ISO 14040 series of standards.

The Environmental Product Declarations (EPD) are just another mark of the transparency espoused by POLYGLASS SpA and the MAPEI Group in their dealings with the market to provide information on the environmental performance of their products and services, according to relevant categories of parameters and following internationally standardized guidelines.

Additional information on the environmental impact of MAPEPLAN T B waterproofing membranes:

- Production system that uses water in a closed loop, hence waste free.
- Production scrap is reused/recycled.
- The POLYGLASS facility complies with all pollution control parameters, including air quality standards.
- POLYGLASS pursues a policy of total energy efficiency (electricity, heating) regarding the production cycle and all business activities.
- POLYGLASS has a cogeneration plant for rational and environmentally conscious electricity production.

LEED CERTIFICATION

MAPEPLAN T B waterproofing membranes help meet the requirements for earning credits for LEED (Leadership in Energy and Environmental Design) certification.

POLYGLASS is a member of the Green Building Council.



8. Advantages of loose laid application with ballast

The loose laid application of all the build-up layers have the advantage to absorb the movements, cracking and dilatations, both of the insulation panel and of the concrete screed if present, without any affection on the waterproofing membrane, that is therefore free to move independently. Therefore, movements, cracking, dilatation and so on, that could occur on the concrete supports, panels, layers or pavings, cannot damage the waterproofing membrane. MAPEPLAN T B gives the maximum performance in terms of “crack bridging”, which is the capacity to create a bridge over the crack.

This system allows to lay the waterproofing membrane on moist supports, indeed a great difference compared to other systems. The positive result is not affected by the eventual moisture on the support.

INSPECTIVE SYSTEMS

The loose laid system offers the possibility to check the surface and weldings of the waterproofing membranes, this is made with “Tracer gas” system or with “high voltage” or “low voltage” electric technology. These systems may be used to check a new waterproofing and to find potential leaks.

Inspection with “TRACER GAS”

It is possible to use specific valves, installed on the waterproofing membrane, to push inside the waterproofed job, a harmless lightweight gas supplied in pressurized canisters. If the waterproofing membrane are not laid correctly and watertight, the lightweight gas comes out from the bottom to the top. The inspector walks on the roof surfaces, using a specific tool provided with a sensor (nose), and searches for potential leaks of the tracer gas to identify any irregularity. The inspector will then issue a test report with the correct positioning of any potential leak found.

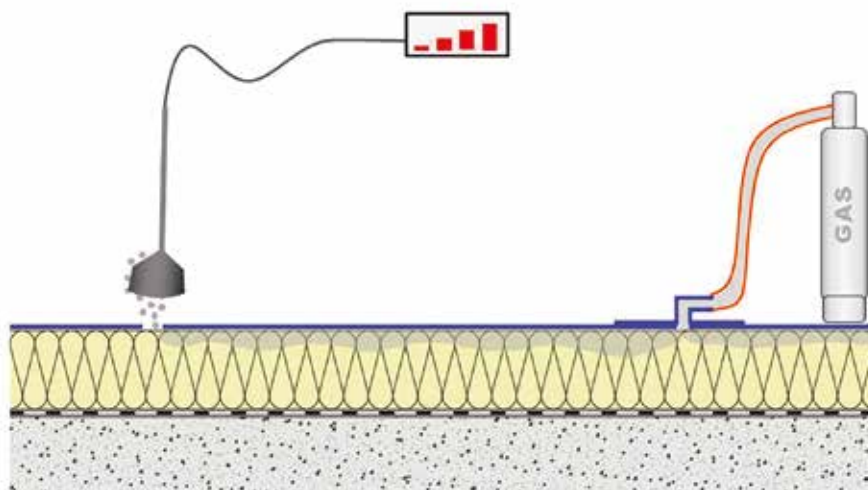

Inspection with HIGH VOLTAGE (Dry test)

This type of inspection uses the properties of non-electric conductivity of the waterproofing membrane MAPEPLAN T B.

The system is made up of an electrically conductive underlayer laid under the waterproofing membrane, a pulse generator of direct high voltage electric current with low intensity, a control tool with metallic brush and connectors are attached to the conductive underlayer.

The generator, connected to the underlayer conductor, gives a direct high voltage electric current pulse with low intensity through the tool brush. The inspector searches for eventual leaks on the horizontal and vertical surfaces of the waterproofing membrane.

The waterproofing membrane is not electrically conductive, therefore if it doesn't have any irregularities, nothing happens. However, if the waterproofing job is not watertight (in case of membrane breaks or incorrect weldings) the electric current passes through and the conductive underlayer makes a close circuit, the brush tool shows a flash and the generator makes an acoustic alarm. This allows to identify where the irregularity is. The inspector will then issue a test report, indicating the positions of any potential leak detected.

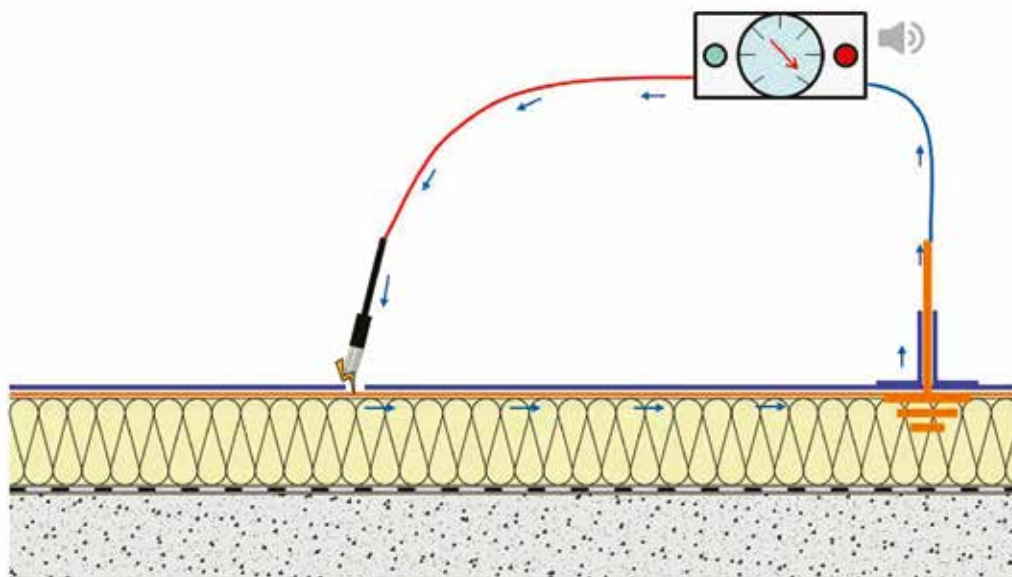

Inspection with LOW VOLTAGE (Wet test)

This system is also called EFVM (Electric Field Vector Mapping). It uses the properties of non-electric conductivity of the waterproofing membrane MAPEPLAN T B, just as the inspection method with high voltage. The system is made up of a pulse generator of direct low voltage electric current with very low intensity, two detector metal sticks, an electric cable used to mark the area to be inspected, and connectors attached to the conductive underlayer.

The generator, connected to the perimeter cable and connectors, makes a pulse of direct low voltage electric current with very low intensity. The surface must be wet to use this system, in order to make a closed circuit.

In case there are no damages on the waterproofing membrane, the inspector doesn't find the electric flow direction. However, if the membranes are not watertight (membrane breaks or incorrect welding) an electrical current flow is generated, it passes by the irregularity and closes the circuit. With the two-stick detector, the inspector walks on the roof surface and follows the flow direction until he gets to the irregular point. This allows to identify the correct position of the irregularity. The inspector will then issue a test report and indicate the positions of the potential leaks detected.

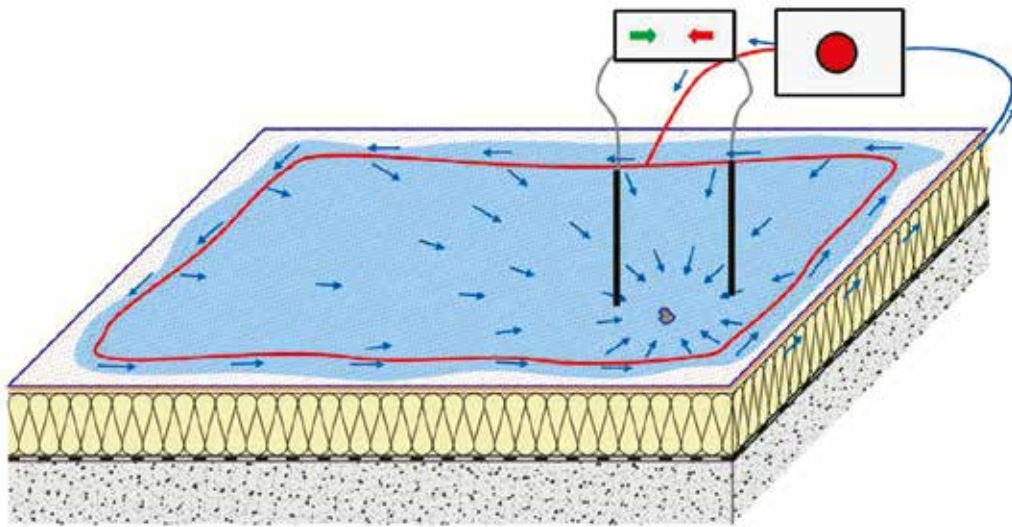

9. Installation instructions

Mechanical fastening at the base of vertical surfaces

The waterproofing membrane MAPEPLAN T B must be mechanically fixed at the base of all vertical surfaces, along all the roof perimeters, skylights, wall connections, etc.

The mechanical fastening is made to avoid movements and tractions of the loose laid waterproofing membrane, due to thermal changes, structural deformations, deformations/movements of the thermal insulation layer and other underlying materials.

In ballasted roofs with gravel or floating pavements, we required to make a linear mechanical fastening with prepunched MAPEPLAN METALBAR bars to be laid on the horizontal or vertical surface.

The anti-tear cord MAPEPLAN T CORD is applicated near the MAPEPLAN METALBAR with hot air welding, on the waterproofing membrane to ensure a linear and uniform distribution of the traction forces.

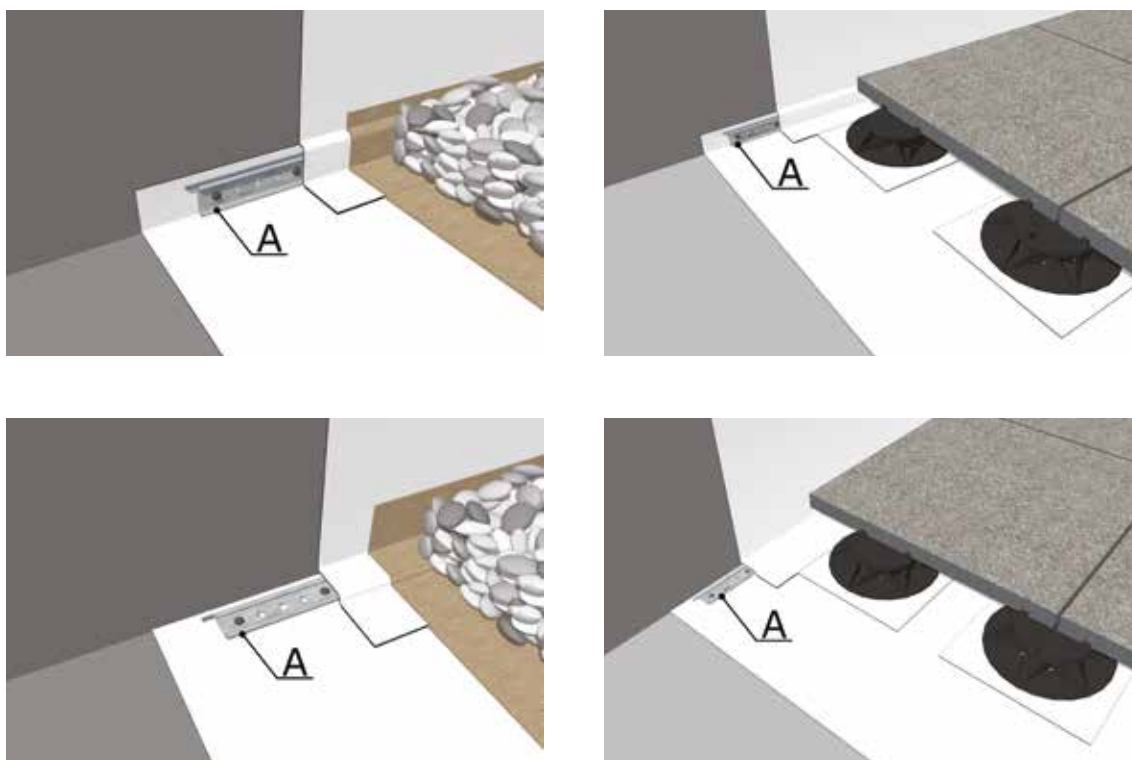

A - Linear mechanical fastening with pre-punched MAPEPLAN METALBAR + MAPEPLAN T CORD + fastening elements (min. 4 pcs/m).

In ballasted roofs for pedestrian or traffic vehicle made with concrete screed, instead, we suggest to make a spot mechanical fastening with metal stress plates and suitable screws/fasteners according to the support, laid on the horizontal or vertical surface.

A continuous linear compressible expanded element must be applied all along the perimeter of the paving/concrete screed to avoid the risk of damaging the waterproofed vertical upstand, due to the possible dilatation and pressure on the edge of the paving caused by thermal changes.

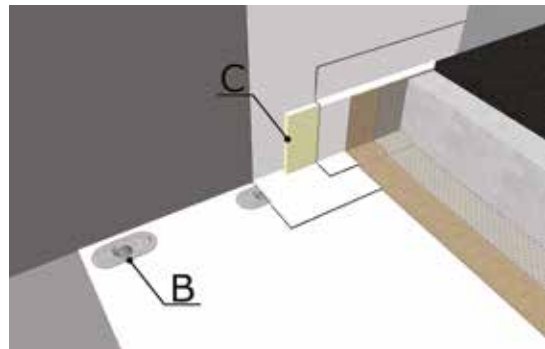
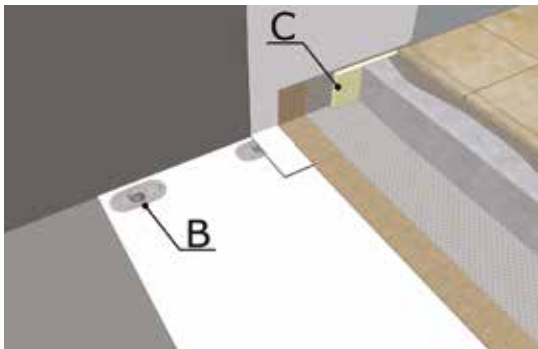
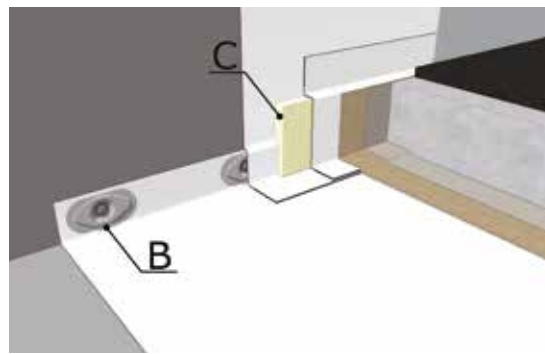
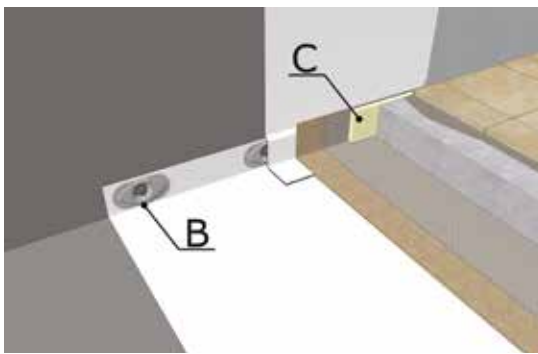

B - Spot mechanical fastening with metal stress plates and suitable screws/fasteners

C - Compressible expanded element

10. System accessories

The waterproofing system of a ballasted roof does not consist of just the waterproofing membrane. All the complementary layers and finishing and junction accessories also play a key role in producing a functional, long-lasting roof.

The MAPEPLAN T B system's accessories and complementary products are outlined below. For more detailed information, please refer to the specific technical data sheets.

PREFABRICATED MAPEPLAN T ACCESSORIES



MAPEPLAN T system accessories include: inside and outside corners, outlets, connections, flashings and other special prefabricated parts.

MAPEPLAN T SEAM PREP



MAPEPLAN T SEAM PREP is an organic-solvent-based liquid cleaner specially formulated for preparing overlaps prior to welding of MAPEPLAN T FPO/TPO waterproofing membranes, to be used to boost the membrane's weldability properties.

MAPEPLAN ADS 300 - MAPEPLAN ADS 310

MAPEPLAN ADS 300 is a polichloroprenic mono-component solvent adhesive for double coating (contact adhesive), designed to bond MAPEPLAN T B membrane on vertical surfaces.

MAPEPLAN ADS 310 is one component solvent adhesive for double coating (contact adhesive), designed to bond MAPEPLAN T B membrane on vertical surfaces, supplied in pressurized canister for spray application.

MAPEPLAN METALBAR - MAPEPLAN T CORD

MAPEPLAN METALBAR is a metal fixing profile in galvanized carbon steel, pre-punched, with oval perforations, to be used around the perimeter of the waterproofing membrane to anchor the sheet.

Anti-tear cord MAPEPLAN T CORD is applied adjacent to the slotted profiles to complete the fastening of the perimeter.

MAPEPLAN T LAMINATED METAL SHEET

Zinc steel sheet having the surface laminated with MAPEPLAN T FPO/TPO waterproofing membrane.

It is resistant to weathering and ultraviolet rays.

These coated metal sheets are used as press-formed finishing profiles and flashings for MAPEPLAN T B membrane.

MAPEPLAN GRAVEL PROFILE



MAPEPLAN GRAVEL PROFILE is a separation and finishing profile for ballasted roofs with gravel or floating pavements, it is provided with oval holes to allow water drainage in frontal side and with oval eyelets for the anchorage with hot air welded strips on roofing membrane MAPEPLAN T.

POLYDREN PP



POLYDREN PP is a 100% polypropylene woven-non-woven geotextile, needle punched and thermocalandered.

POLYDREN PP has been manufactured to meet standards EN 13249; EN 13254; EN 13250; EN 13255; EN 13251; EN13256; EN 13252; EN 13257; EN 13253; EN 13265.

It is used as a levelling, protection and filter layer in ballasted roof construction.

MAPEPLAN PE micro-perforated

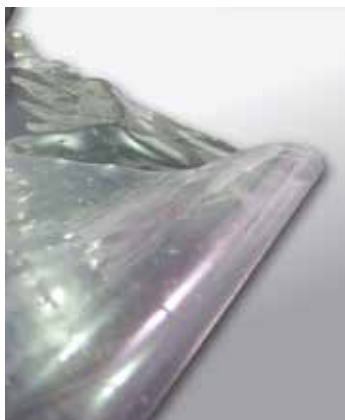

MAPEPLAN PE micro-perforated is an anti-soaking layer made from lowdensity polyethylene LDPE of transparent color, with a nominal thickness of 0.10 mm and having a micro-perforation, which makes it permeable to vapor.

When producing build-up systems for warm, cold and inverted roofs, it is laid before the protective concrete screed is poured.

The micro-perforation means inspection and testing can be carried out with the “Tracer gas” and “Geoelectric” system.

POLYSTUOIA 20 - POLYSTUOIA 20 L



POLYSTUOIA 20 and POLYSTUOIA 20L are protective and drainage geocomposites comprising two UV-stabilized, needle-punched polypropylene staple-fiber filter geotextiles with a 3-dimensional drainage structure sandwiched between them made up of polypropylene monofilaments.

The two geotextiles are heat bonded to the drainage core using a continuous process.

Meet the requirements of standard EN 13252.

MAPEPLAN VB PE SD 220



MAPEPLAN VB PE SD 220 is a synthetic sheet in polyethylene, of blue color, having a nominal thickness of 0,25 mm and S_d value of 220 m. It is used as vapor control layers and functional element for insulated roof build-ups, to be applied on the “warm side” of the thermal insulation

IDROPRIMER



IDROPRIMER is a water-based bituminous primer made with select bitumen used as an adhesion promoter and dust-repellent primer before laying prefabricated bitumen membranes, in this case used as a vapor barrier.

It has the major advantage of not being flammable and being odorless.

POLYVAP SA P-AL



POLYVAP SA P-AL is a prefabricated double-sided self-adhesive bitumen membrane produced using ADESO technology, made up of a special selfadhesive elastomeric compound (SBS) reinforced with an aluminum foil. For use as a vapor barrier, it meets the requirements of standard EN 13970. Its use is recommended in all cases where application does not involve torching.

POLYVAP RADONSHIELD P-AL



POLYVAP RADONSHIELD P-AL is a prefabricated waterproofing elastomeric-plastomeric membrane, with a distilled bitumen-based compound modified with polypropylene, reinforced with a 6/100 thickness aluminum strip bonded to reinforced glass fiber. For use as a vapor barrier and as a provisional waterproofing measure to stop water getting in temporarily, it meets the requirements of standard EN 13970.

PLANA P



PLANA P is a prefabricated waterproofing elastomeric-plastomeric membrane, with a distilled bitumen-based compound modified with polypropylene and staple non-woven polyester fabric reinforcement. For use as a vapor barrier and as a provisional waterproofing measure to stop water getting in temporarily, it meets the requirements of standard EN 13970 and EN 13707.

POLYVAP FIX P - POLYVAP FIX P-AL

POLYVAP FIX P e POLYVAP FIX P-AL are a prefabricated waterproofing elastomeric membrane. POLYVAP FIX P is a vapor underlay featuring a spunbond polyester nonwoven carrier stabilized and reinforced with glass strands parallel to the machine direction. POLYVAP FIX P-AL is a vapor barrier featuring a glass fiber stabilized polyester fabric carrier laminated with aluminum foil, set within the membrane.

For use as a vapor barrier and as a provisional waterproofing measure to stop water getting in temporarily, it meets the requirements of standard EN 13970.

11. Technical drawings

ROOF PARAPET

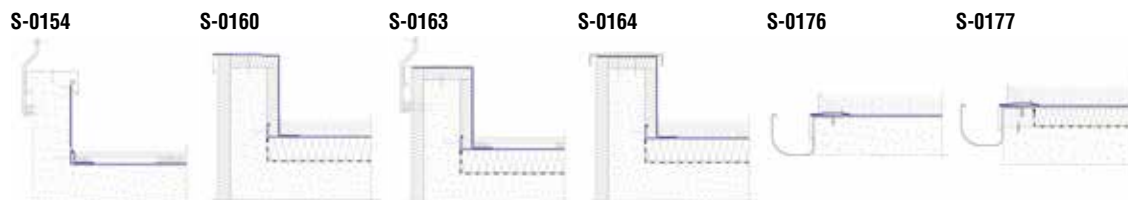

WALL CONNECTION

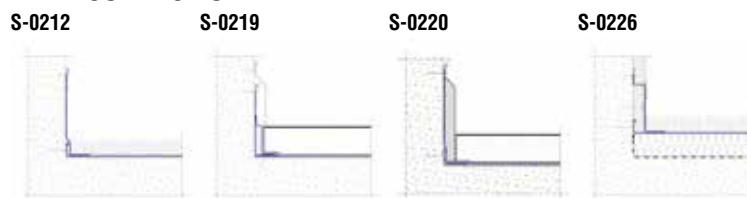

SKYLIGHT / GRATING / THRESHOLD CONNECTION

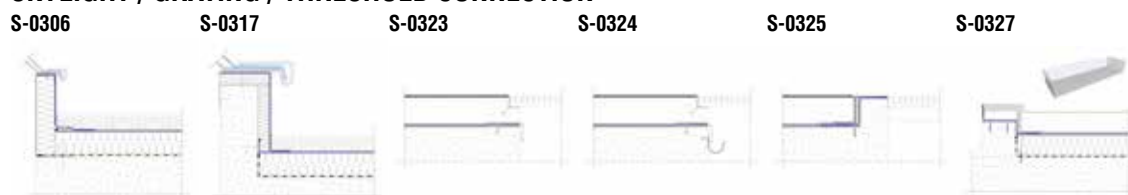

ROOF DRAIN

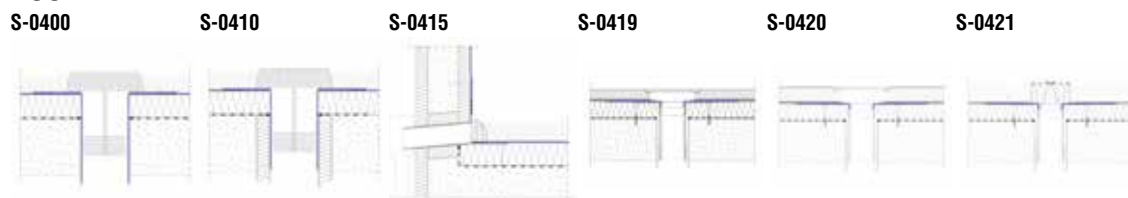

PIPE / ANCHOR CONNECTION

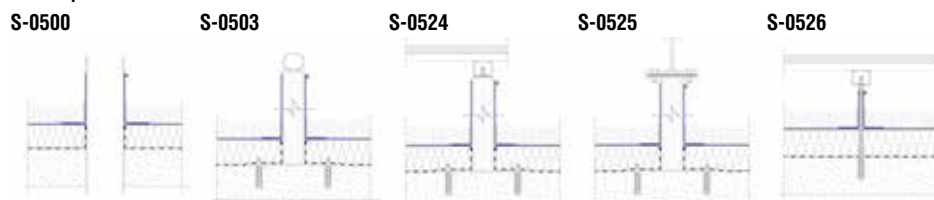

EXPANSION JOINT / ROOF ZONES CONNECTION

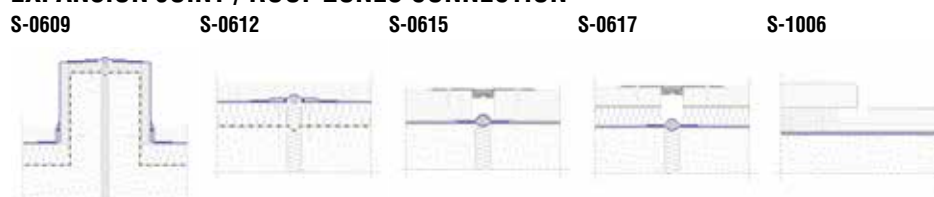

Detail S-0154 - Roof parapet

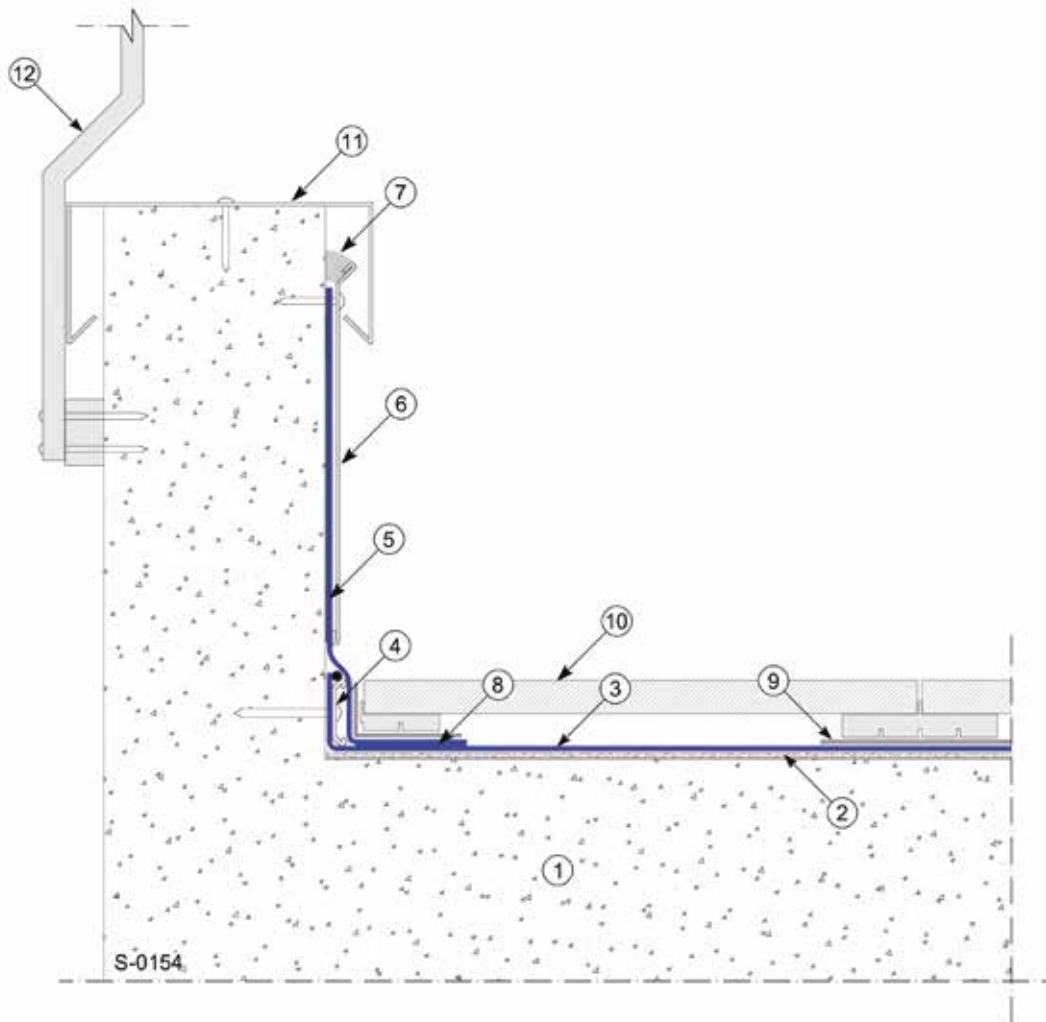

- | | |
|---|--|
| ① Structure | ⑦ Sealing with MAPEPLAN SEALANT KIT |
| ② Levelling layer POLYDREN PP | ⑧ Welding |
| ③ Waterproofing membrane MAPEPLAN T B | ⑨ MAPEPLAN T protection patch |
| ④ Mechanical fastening MAPEPLAN METALBAR + MAPEPLAN T CORD | ⑩ Floating pavement |
| ⑤ Fully adhered MAPEPLAN T waterproofing membrane | ⑪ Finishing flashing |
| ⑥ Metal flashing | ⑫ Parapet |

Detail S-0160 - Roof parapet

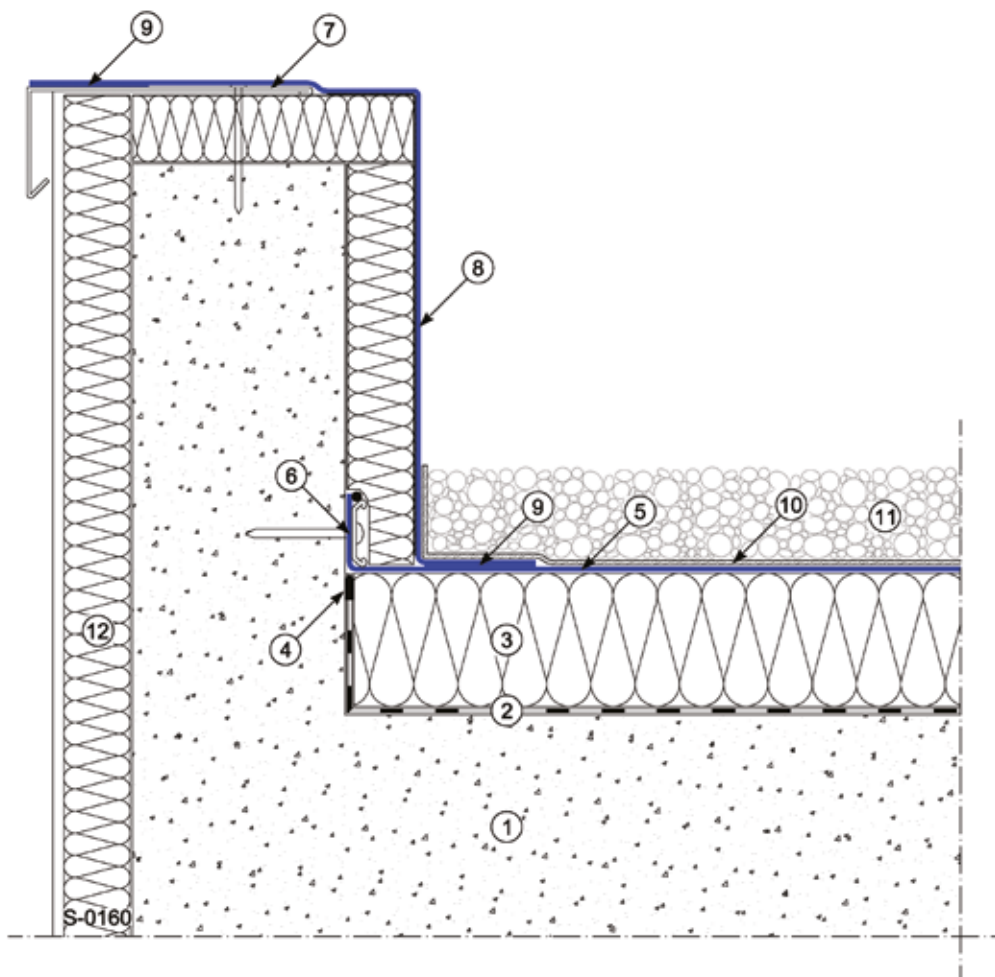

- | | |
|---|--|
| <ul style="list-style-type: none"> ① Structure ② Vapour barrier sealed on overlaps and on perimeters (e.g. MAPEPLAN VB PE SD 220 or IDROPRIMER + POLYVAP) ③ Thermal insulation layer ④ Perimeter sealing ⑤ Waterproofing membrane MAPEPLAN T B ⑥ Mechanical fastening MAPEPLAN METALBAR + MAPEPLAN T CORD | <ul style="list-style-type: none"> ⑦ MAPEPLAN T perimeter profile ⑧ Fully adhered MAPEPLAN T waterproofing membrane ⑨ Welding ⑩ Protection layer POLYDREN PP ⑪ Gravel ⑫ Façade insulation panel |
|---|--|

Detail S-0163 - Roof parapet

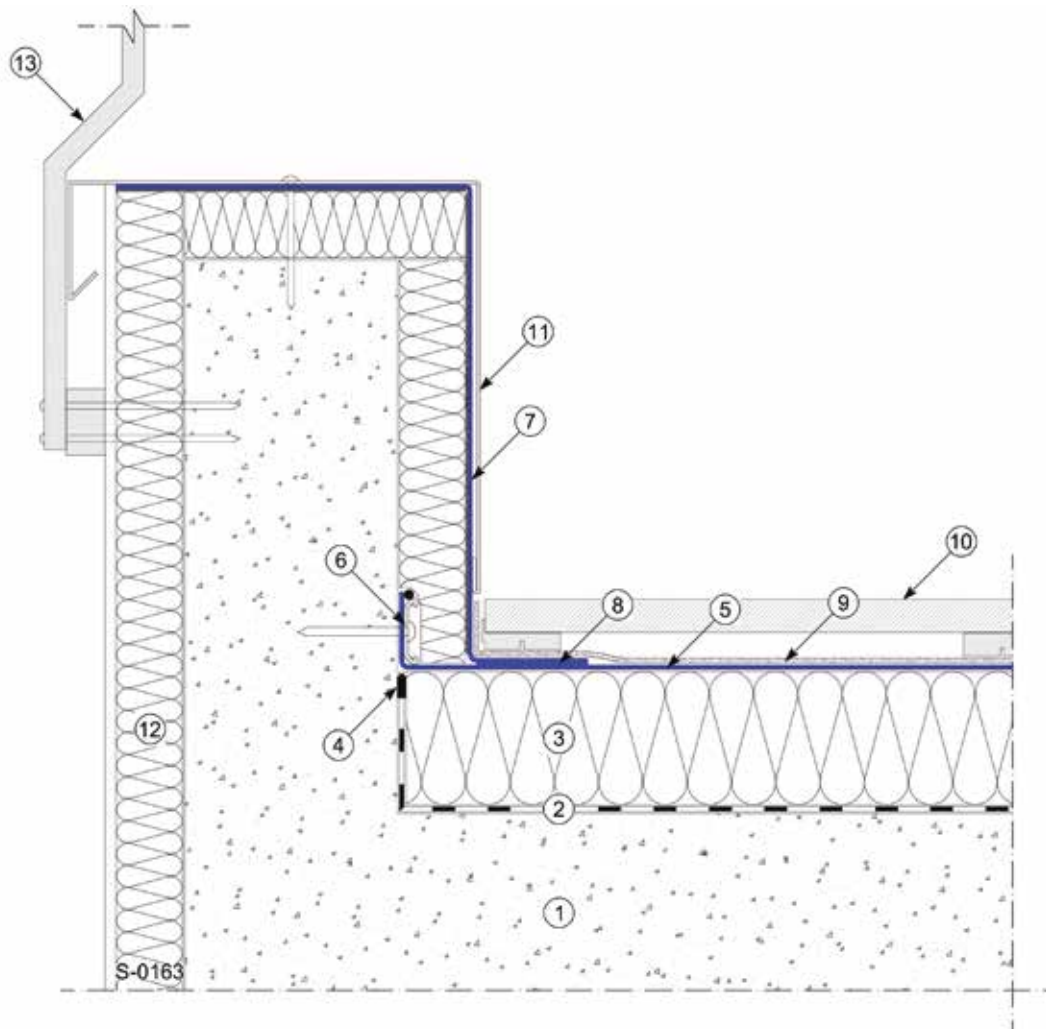

- | | |
|--|--|
| ① Structure | ⑦ Fully adhered MAPEPLAN T waterproofing membrane |
| ② Vapour barrier sealed on overlaps and on perimeters
(e.g. MAPEPLAN VB PE SD 220 or IDROPRIMER + POLYVAP) | ⑧ Welding |
| ③ Thermal insulation layer | ⑨ Protection layer POLYDREN PP |
| ④ Perimeter sealing | ⑩ Floating pavement |
| ⑤ Waterproofing membrane MAPEPLAN T B | ⑪ Metal flashing |
| ⑥ Mechanical fastening MAPEPLAN METALBAR + MAPEPLAN T CORD | ⑫ Façade insulation panel |
| | ⑬ Parapet |

Detail S-0164 - Roof parapet

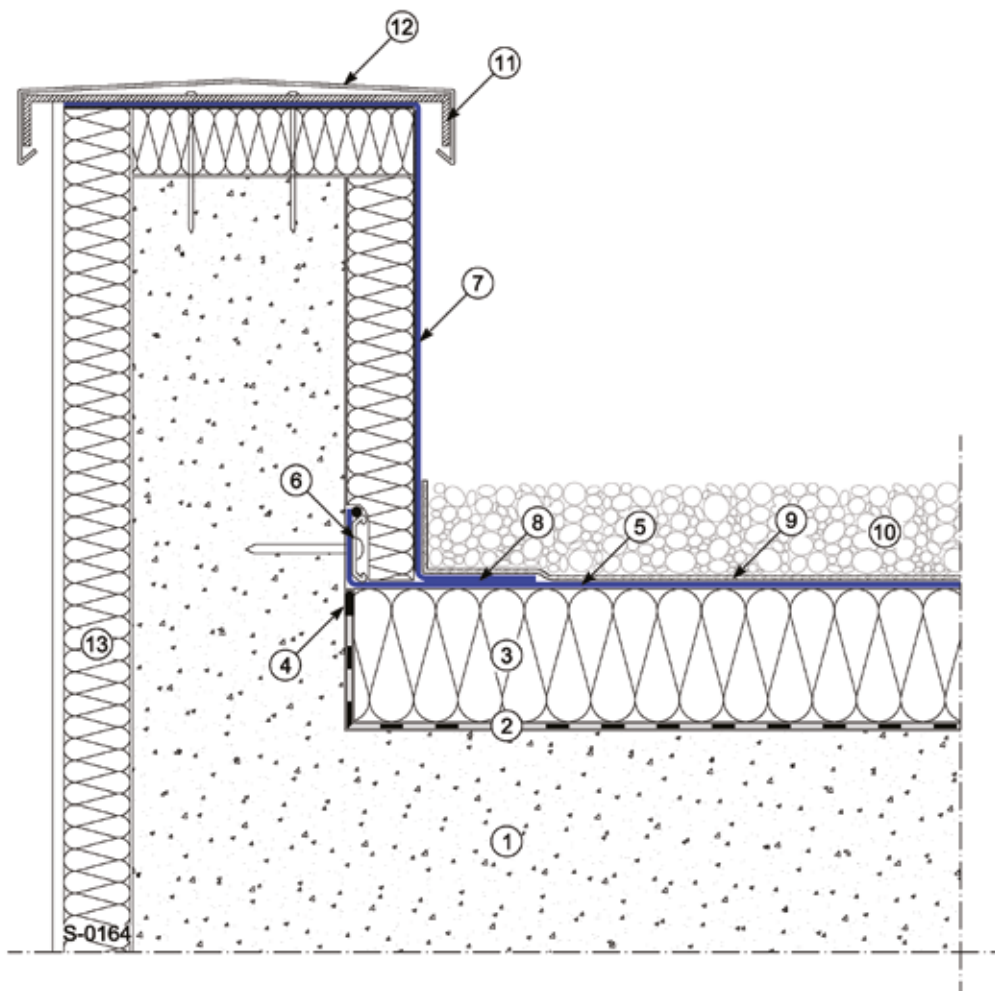

- | | |
|--|--|
| ① Structure | ⑦ Fully adhered MAPEPLAN T waterproofing membrane |
| ② Vapour barrier sealed on overlaps and on perimeters
(e.g. MAPEPLAN VB PE SD 220 or IDROPRIMER + POLYVAP) | ⑧ Welding |
| ③ Thermal insulation layer | ⑨ Protection layer POLYDREN PP |
| ④ Perimeter sealing | ⑩ Gravel |
| ⑤ Waterproofing membrane MAPEPLAN T B | ⑪ Anchor bracket |
| ⑥ Mechanical fastening MAPEPLAN METALBAR + MAPEPLAN T CORD | ⑫ Finishing flashing |
| | ⑬ Façade insulation panel |

Detail S-0176 - Roof parapet

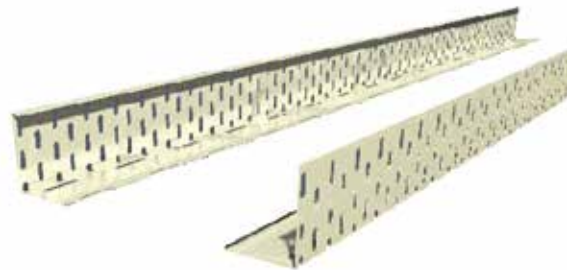

Detail MAPEPLAN Gravel Profile

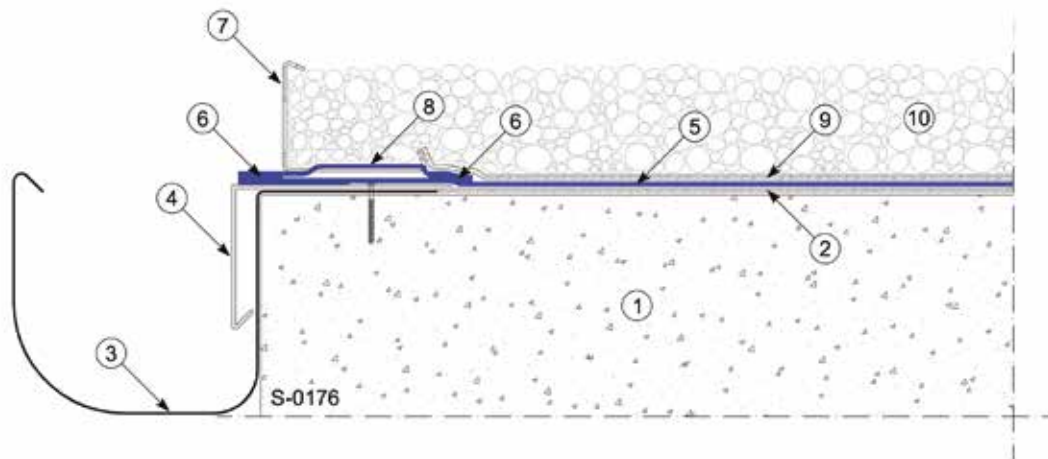

- | | |
|--|--|
| ① Structure | ⑥ Welding |
| ② Levelling layer POLYDREN PP | ⑦ MAPEPLAN Gravel Profile |
| ③ Gutter | ⑧ Strip of membrane MAPEPLAN T for fixation of Gravel profile |
| ④ MAPEPLAN T perimeter profile | ⑨ Protection layer POLYDREN PP |
| ⑤ Waterproofing membrane MAPEPLAN T B | ⑩ Gravel |

Detail S-0177 - Roof parapet



Detail MAPEPLAN Gravel Profile

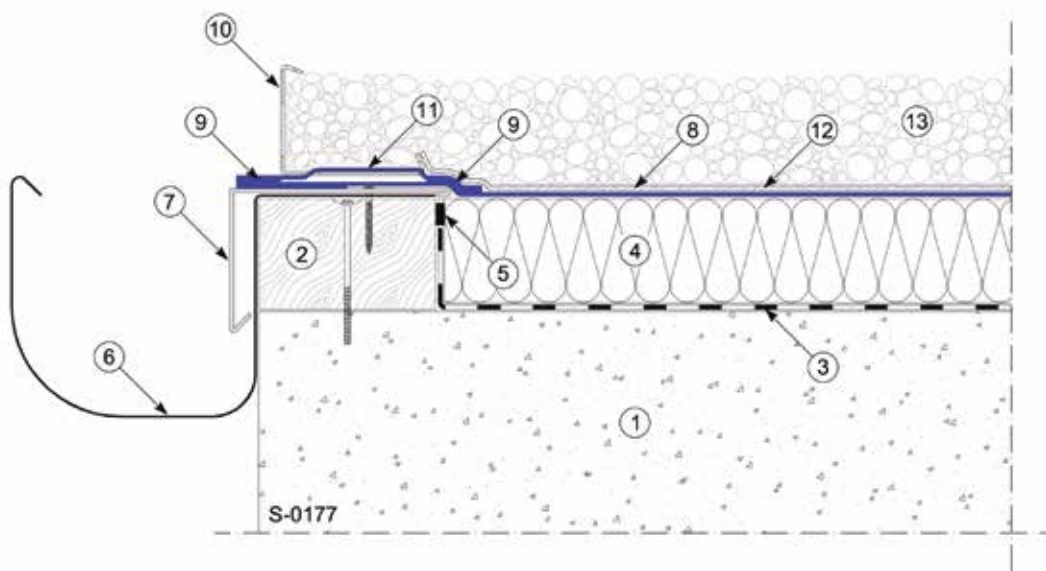

- | | |
|---|---|
| <ul style="list-style-type: none"> ① Structure ② Containment wooden batten ③ Vapour barrier sealed on overlaps and on perimeters
(e.g. MAPEPLAN VB PE SD 220 or IDROPRIMER + POLYVAP) ④ Thermal insulation layer ⑤ Perimeter sealing ⑥ Gutter | <ul style="list-style-type: none"> ⑦ MAPEPLAN T perimeter profile ⑧ Waterproofing membrane MAPEPLAN T B ⑨ Welding ⑩ MAPEPLAN Gravel Profile ⑪ Strip of membrane MAPEPLAN T for fixation of Gravel profile ⑫ Protection layer POLYDREN PP ⑬ Gravel |
|---|---|

Detail S-0212 - Wall connection

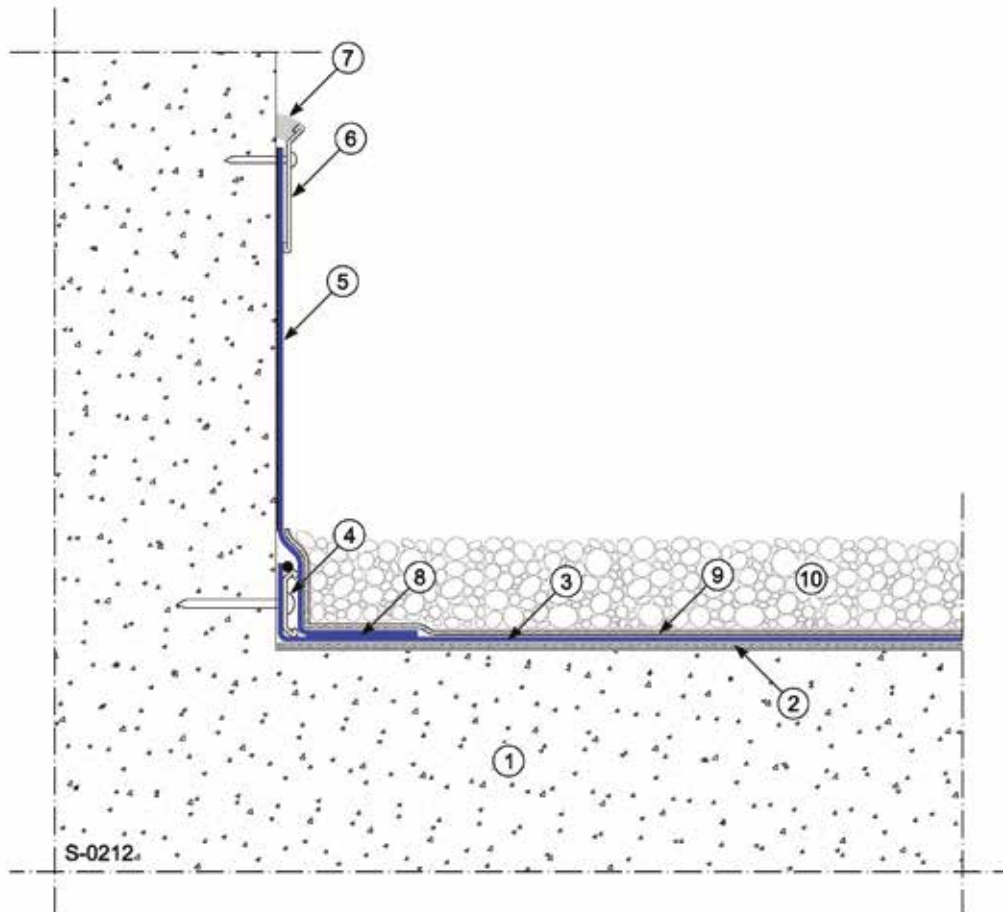

- | | |
|---|---|
| ① Structure | ⑥ MAPEPLAN T termination strip profile |
| ② Levelling layer POLYDREN PP | ⑦ Sealing with MAPEPLAN SEALANT KIT |
| ③ Waterproofing membrane MAPEPLAN T B | ⑧ Welding |
| ④ Mechanical fastening MAPEPLAN METALBAR + MAPEPLAN T CORD | ⑨ Protection layer POLYDREN PP |
| ⑤ Fully adhered MAPEPLAN T waterproofing membrane | ⑩ Gravel |

Detail S-0219 - Wall connection

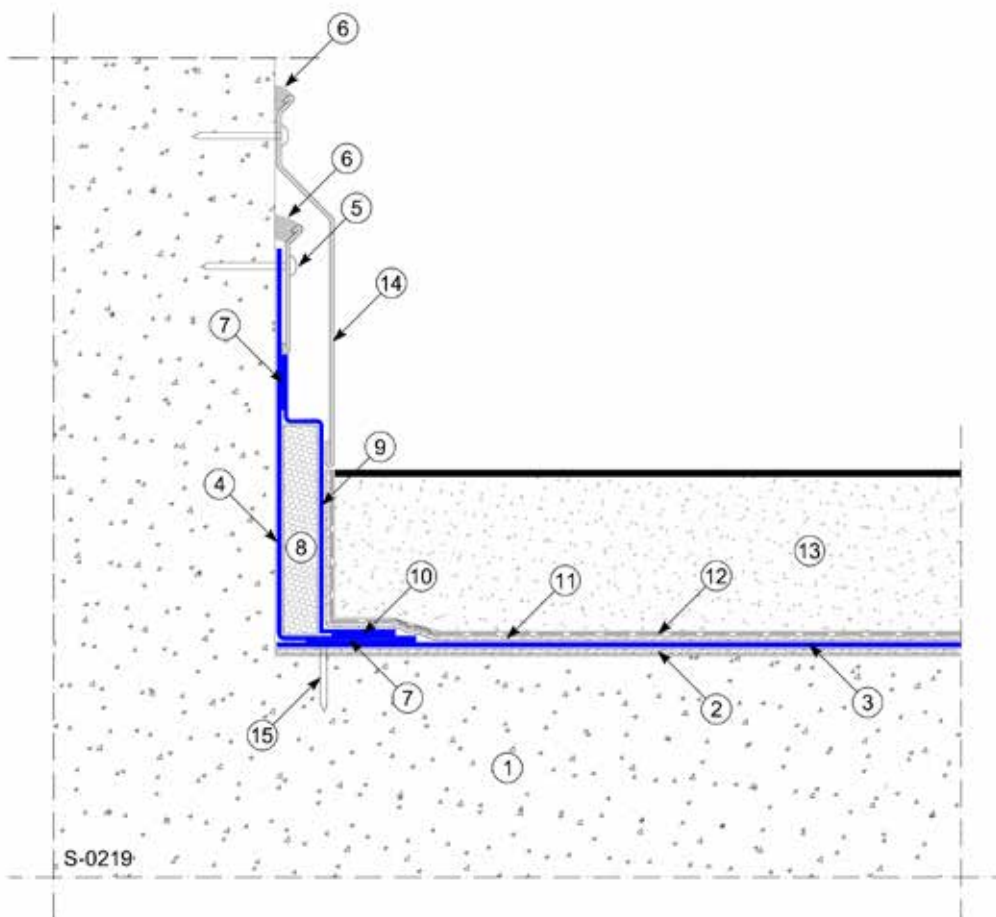

- | | |
|--|--|
| ① Structure | ⑨ Strip of MAPEPLAN T membrane |
| ② Levelling layer POLYDREN PP | ⑩ Spot welding |
| ③ Waterproofing membrane MAPEPLAN T B | ⑪ Protection layer POLYDREN PP |
| ④ Fully adhered MAPEPLAN T waterproofing membrane | ⑫ MAPEPLAN PE micro-perforated separation and antisoaking layer |
| ⑤ MAPEPLAN T termination strip profile | ⑬ Concrete screed with asphalt surface course |
| ⑥ Sealing with MAPEPLAN SEALANT KIT | ⑭ Finishing flashing |
| ⑦ Welding | ⑮ Perimeter mechanical fixation with washer |
| ⑧ Compressible expanded element | |

Detail S-0220 - Wall connection

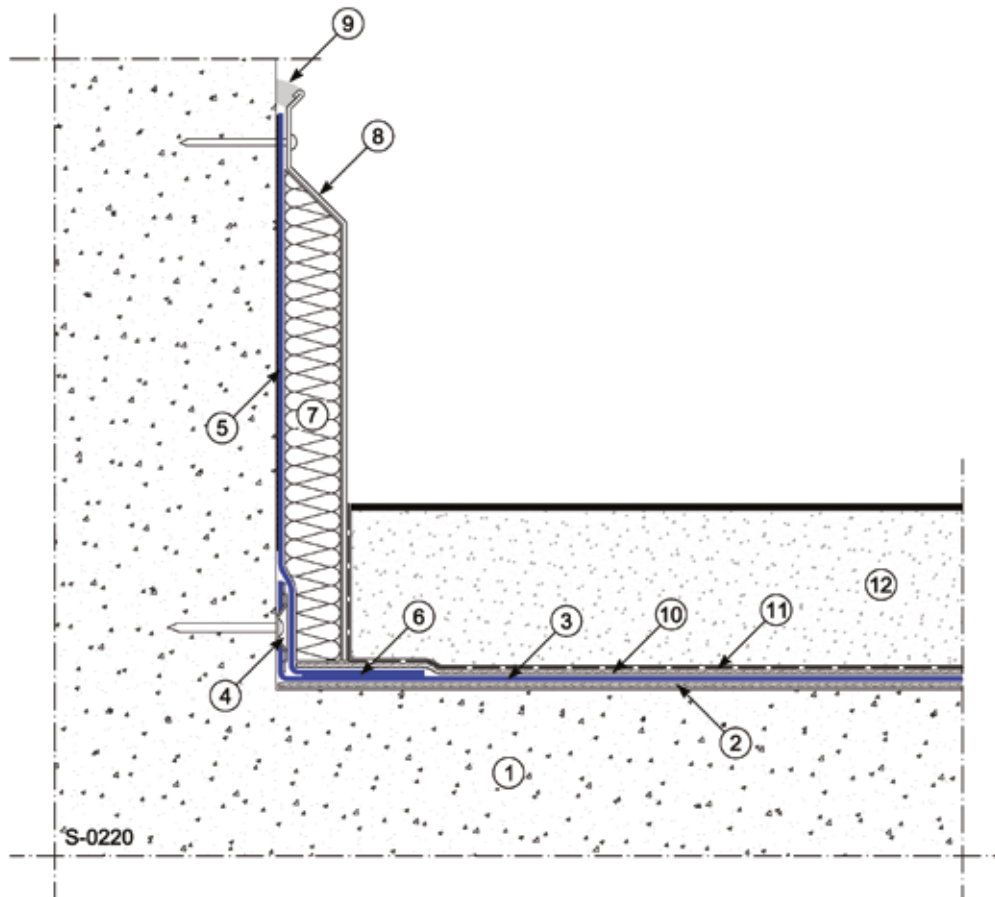

- | | |
|--|--|
| ① Structure | ⑧ Metal flashing |
| ② Levelling layer POLYDREN PP | ⑨ Sealing with MAPEPLAN SEALANT KIT |
| ③ Waterproofing membrane MAPEPLAN T B | ⑩ Protection layer POLYDREN PP |
| ④ Perimeter mechanical fixation with washer | ⑪ MAPEPLAN PE micro-perforated separation and antisoaking layer |
| ⑤ Fully adhered MAPEPLAN T waterproofing membrane | ⑫ Concrete screed with asphalt surface course |
| ⑥ Welding | |
| ⑦ Compressible expanded element | |

Detail S-0226 - Wall connection

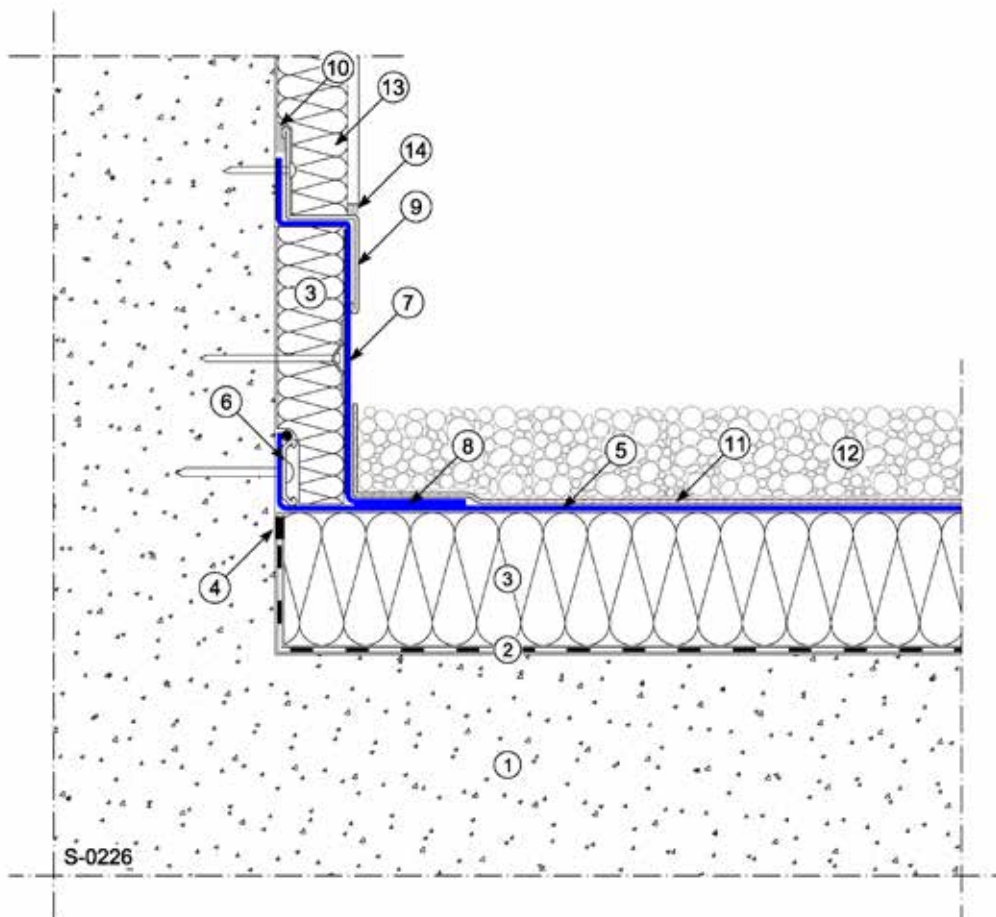

- | | |
|---|--|
| ① Structure | ⑦ Fully adhered MAPEPLAN T waterproofing membrane |
| ② Vapor barrier sealed on overlaps and on perimeters
(e.g. MAPEPLAN VB PE SD 220 or IDROPRIMER + POLYVAP) | ⑧ Welding |
| ③ Thermal insulation layer | ⑨ Metal flashing |
| ④ Perimeter sealing | ⑩ Sealing with MAPEPLAN SEALANT KIT |
| ⑤ Waterproofing membrane MAPEPLAN T B | ⑪ Protection layer POLYDREN PP |
| ⑥ Mechanical fastening MAPEPLAN METALBAR + MAPEPLAN T CORD | ⑫ Gravel |
| | ⑬ Façade insulation panel |
| | ⑭ Elastic sealing |

Detail S-0306 - Skylight connection

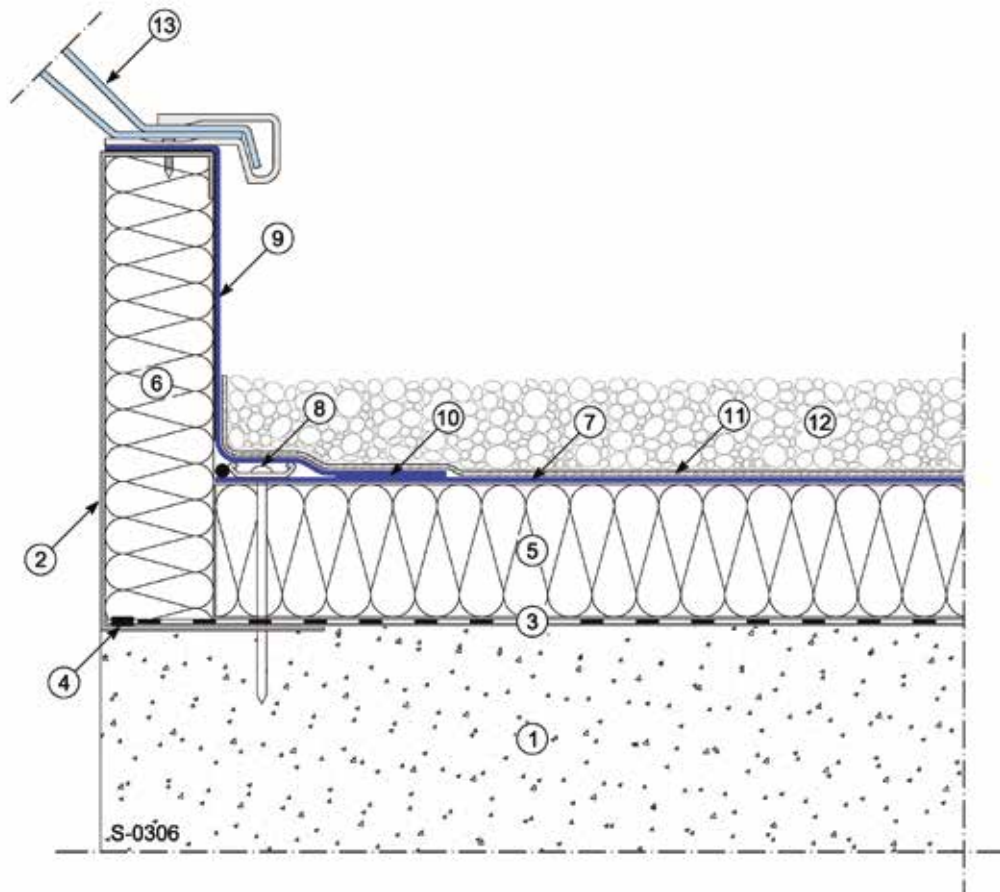

- | | |
|--|---|
| ① Structure | ⑦ Waterproofing membrane MAPEPLAN T B |
| ② Skylight basement | ⑧ Mechanical fastening MAPEPLAN METALBAR + MAPEPLAN T CORD |
| ③ Vapor barrier sealed on overlaps and on perimeters (e.g. MAPEPLAN VB PE SD 220 or IDROPRIMER + POLYVAP) | ⑨ Fully adhered MAPEPLAN T waterproofing membrane |
| ④ Perimeter sealing | ⑩ Welding |
| ⑤ Thermal insulation layer | ⑪ Protection layer POLYDREN PP |
| ⑥ Insulation panel PUR/PIR with glass veil | ⑫ Gravel |
| | ⑬ Skylight |

Detail S-0317 - Skylight connection

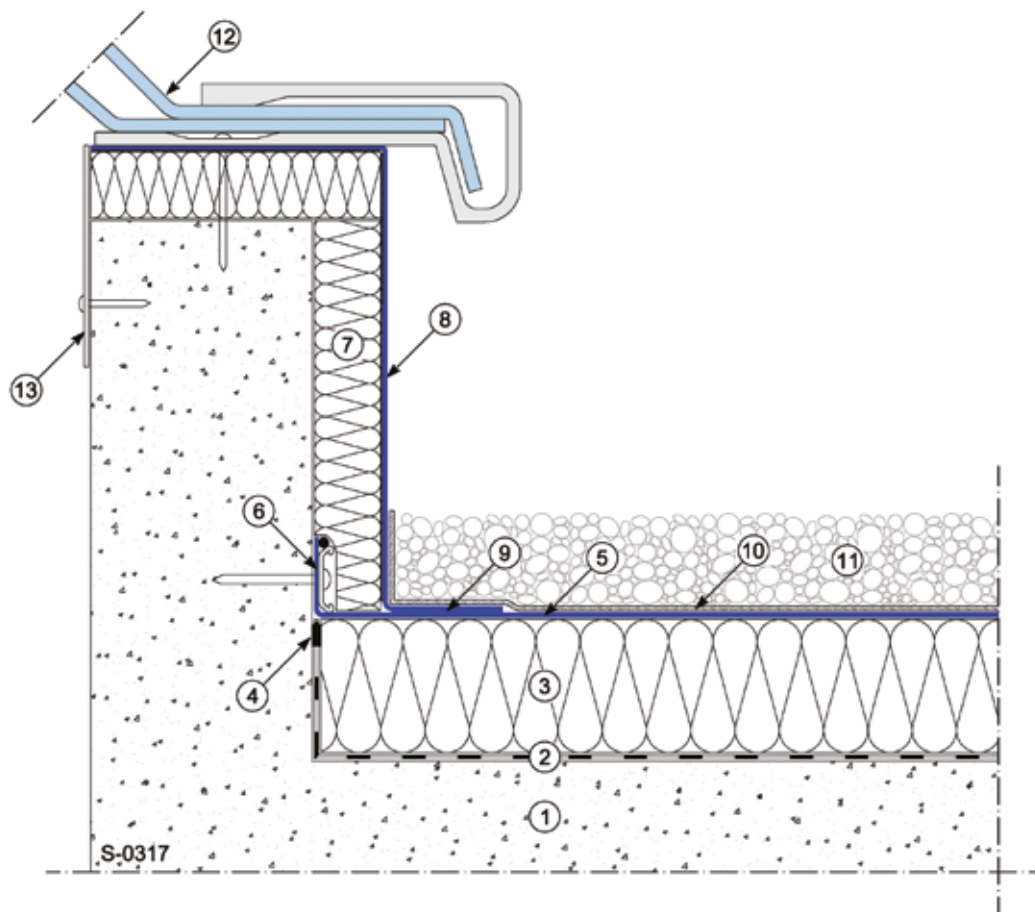

- | | |
|---|---|
| ① Structure | ⑦ Insulation panel PUR/PIR with glass veil mechanically fixed |
| ② Vapor barrier sealed on overlaps and on perimeters
(e.g. MAPEPLAN VB PE SD 220 or IDROPRIMER + POLYVAP) | ⑧ Fully adhered MAPEPLAN T waterproofing membrane |
| ③ Thermal insulation layer | ⑨ Welding |
| ④ Perimeter sealing | ⑩ Protection layer POLYDREN PP |
| ⑤ Waterproofing membrane MAPEPLAN T B | ⑪ Gravel |
| ⑥ Mechanical fastening MAPEPLAN METALBAR + MAPEPLAN T CORD | ⑫ Skylight |
| | ⑬ Closing and/or flashing profile |

Detail S-0323 - Grating connection

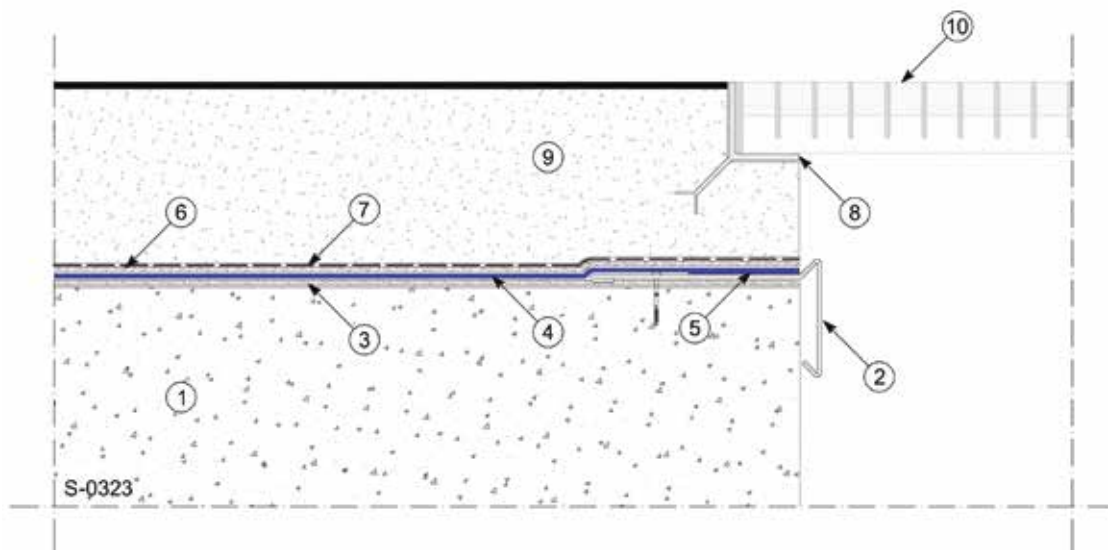

- | | |
|--|---|
| <ul style="list-style-type: none"> ① Structure ② MAPEPLAN T Profile ③ Levelling layer POLYDREN PP ④ Waterproofing membrane MAPEPLAN T B ⑤ Welding ⑥ Protection layer POLYDREN PP | <ul style="list-style-type: none"> ⑦ MAPEPLAN PE micro-perforated separation and antisoaking layer ⑧ Frame for metallic grating ⑨ Concrete screed with asphalt surface course ⑩ Metallic grating for pedestrian and/or vehicle traffic |
|--|---|

Detail S-0324 - Grating connection

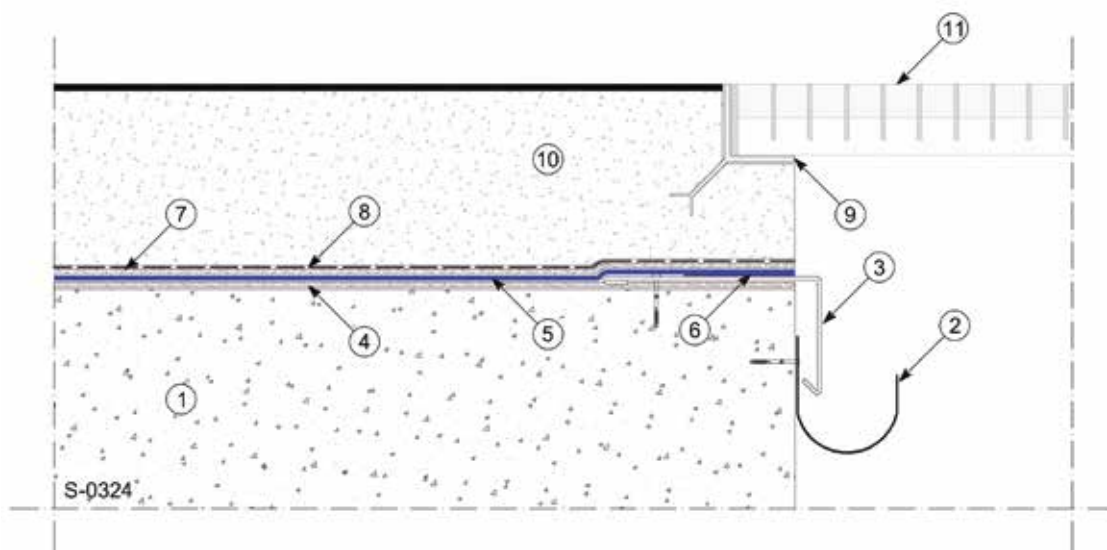

- | | |
|---|--|
| <ul style="list-style-type: none"> ① Structure ② Gutter ③ MAPEPLAN T perimeter profile ④ Levelling layer POLYDREN PP ⑤ Waterproofing membrane MAPEPLAN T B ⑥ Welding | <ul style="list-style-type: none"> ⑦ Protection layer POLYDREN PP ⑧ MAPEPLAN PE micro-perforated separation and antisoaking layer ⑨ Frame for metallic grating ⑩ Concrete screed with asphalt surface course ⑪ Metallic grating for pedestrian and/or vehicle traffic |
|---|--|

Detail S-0325 - Grating connection

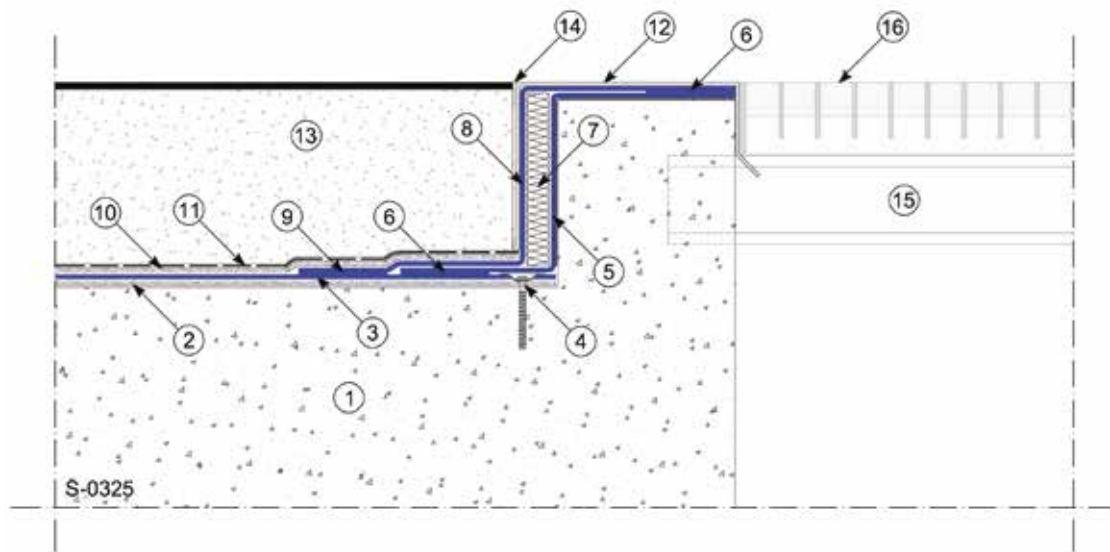

- | | |
|--|--|
| ① Structure | ⑩ Protection layer POLYDREN PP |
| ② Levelling layer POLYDREN PP | ⑪ MAPEPLAN PE micro-perforated separation and antisoaking layer |
| ③ Waterproofing membrane MAPEPLAN T B | ⑫ Metal flashing |
| ④ Perimeter mechanical fixation with washer | ⑬ Concrete screed with asphalt surface course |
| ⑤ Fully adhered MAPEPLAN T waterproofing membrane | ⑭ Elastic sealing |
| ⑥ Welding | ⑮ Metal support beam |
| ⑦ Compressible expanded element | ⑯ Metallic grating for pedestrian and/or vehicle traffic |
| ⑧ Waterproofing membrane MAPEPLAN T | |
| ⑨ Spot welding | |

Detail S-0326 - Threshold connection

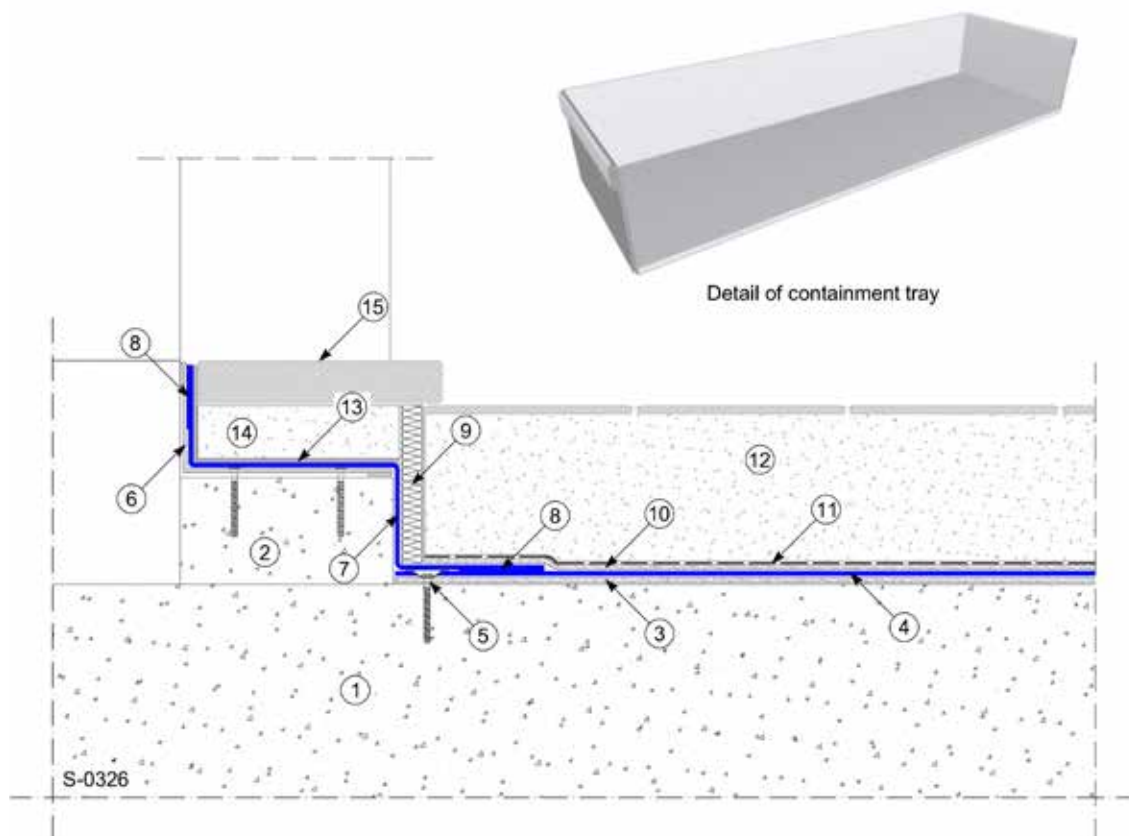

- | | |
|--|---|
| <ul style="list-style-type: none"> ① Structure ② Step under threshold ③ Levelling layer POLYDREN PP ④ Waterproofing membrane MAPEPLAN T B ⑤ Perimeter mechanical fixation with washer ⑥ Container with MAPEPLAN T metal profile ⑦ Fully adhered MAPEPLAN T waterproofing membrane ⑧ Welding ⑨ Compressible expanded element | <ul style="list-style-type: none"> ⑩ Protection layer POLYDREN PP ⑪ MAPEPLAN PE micro-perforated separation and antisoaking layer ⑫ Paving with tile flooring ⑬ Rough surface sprinkled with sand (MAPEPLAN ADS 300 + sand) ⑭ Cement mortar layer ⑮ Threshold with stone or concrete |
|--|---|

Detail S-0327 - Threshold connection

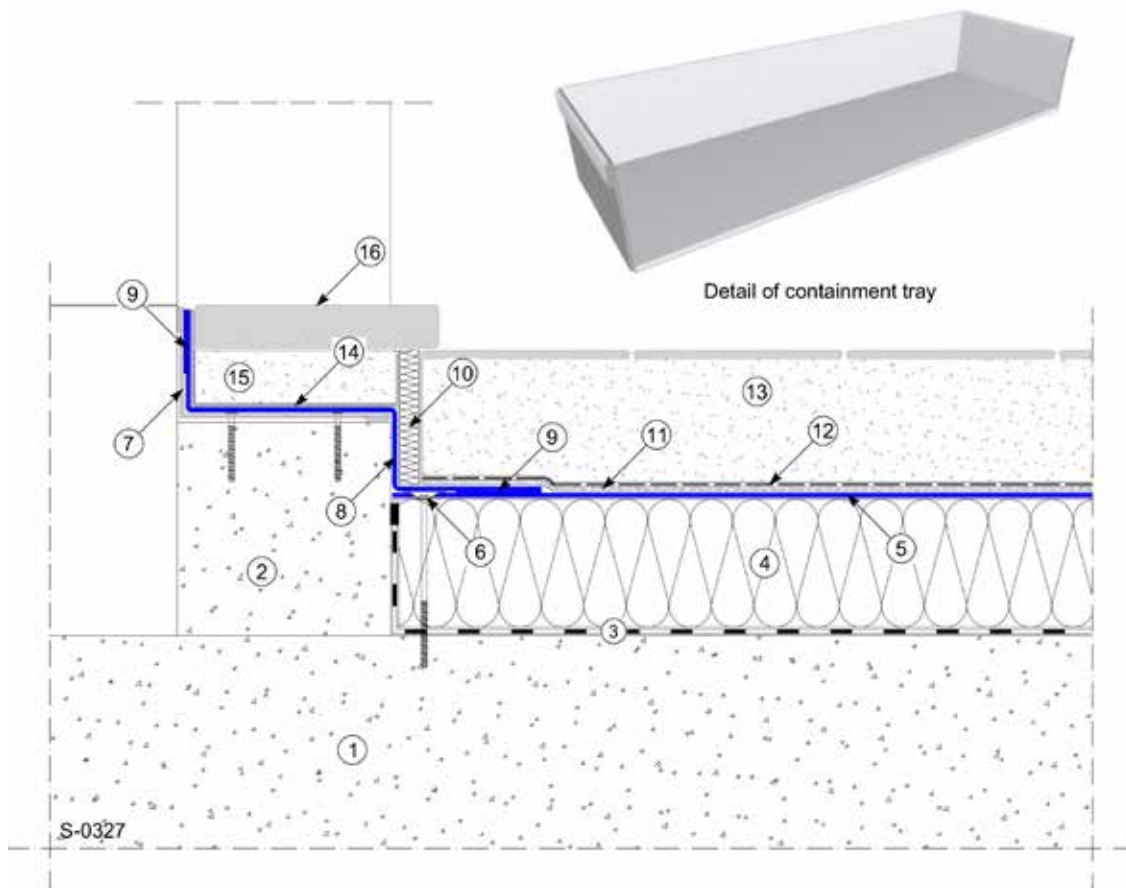

- | | |
|---|--|
| ① Structure | ⑨ Welding |
| ② Step under threshold | ⑩ Compressible expanded element |
| ③ Vapour barrier sealed on overlaps and on perimeters
(e.g. MAPEPLAN VB PE SD 220 or IDROPRIMER + POLYVAP) | ⑪ Protection layer POLYDREN PP |
| ④ Thermal insulation layer | ⑫ MAPEPLAN PE micro-perforated separation and antisoaking layer |
| ⑤ Waterproofing membrane MAPEPLAN T B | ⑬ Paving with tile flooring |
| ⑥ Perimeter mechanical fixation with washer | ⑭ Rough surface sprinkled with sand(MAPEPLAN ADS 300 + sand) |
| ⑦ Container with MAPEPLAN T metal profile | ⑮ Cement mortar layer |
| ⑧ Fully adhered MAPEPLAN T waterproofing membrane | ⑯ Threshold with stone or concrete |

Detail S-0400 - Roof drain

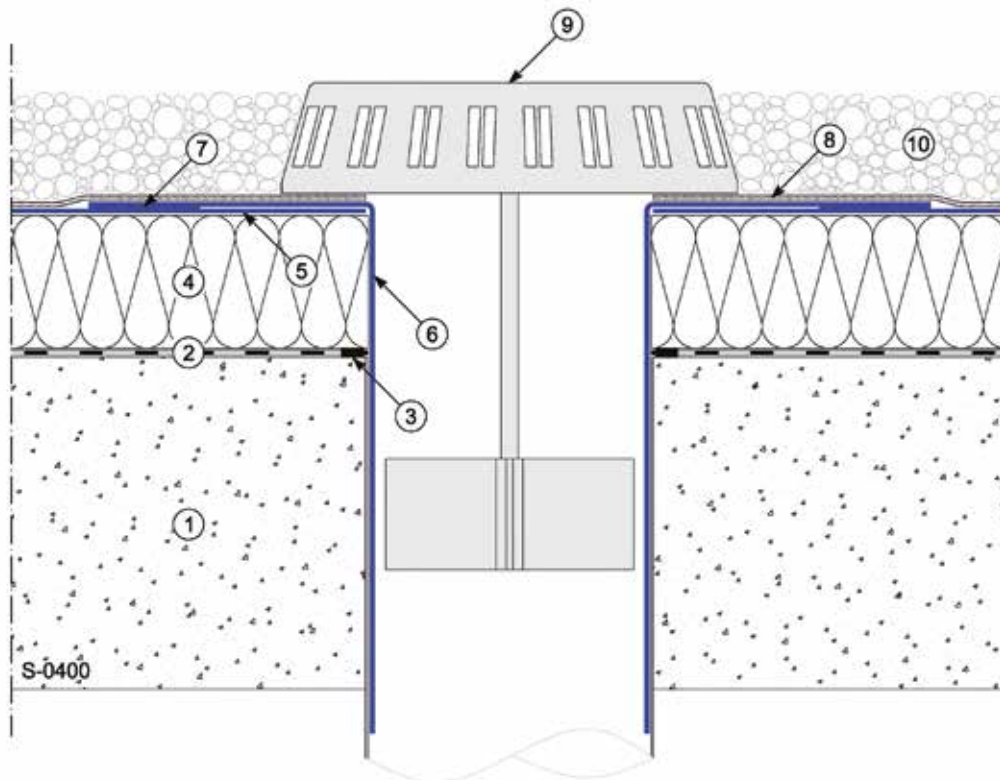

- ① Structure
- ② Vapour barrier sealed on overlaps and on perimeters (e.g. **MAPEPLAN VB PE SD 220** or **IDROPRIMER + POLYVAP**)
- ③ Perimeter sealing
- ④ Thermal insulation layer

- ⑤ Waterproofing membrane **MAPEPLAN T B**
- ⑥ **MAPEPLAN T** outlet
- ⑦ Welding
- ⑧ Protection layer **POLYDREN PP**
- ⑨ Leaf/gravel guard
- ⑩ Gravel

Detail S-0410 - Roof drain

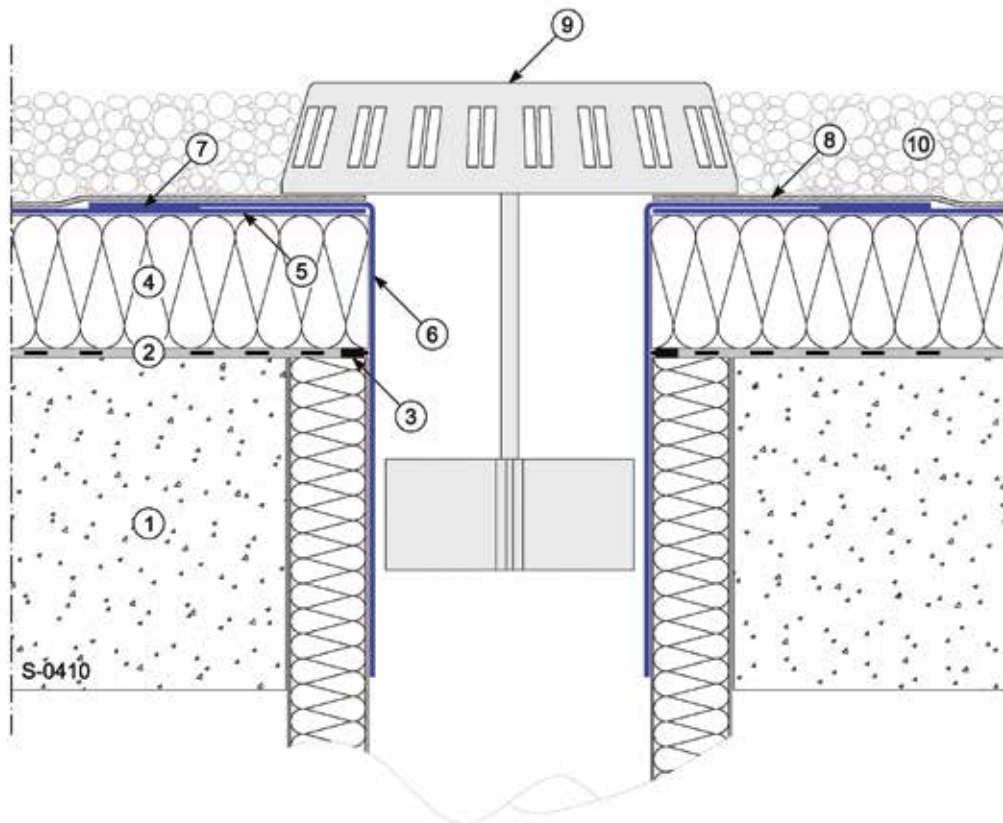

- ① Structure
- ② Vapour barrier sealed on overlaps and on perimeters
(e.g. **MAPEPLAN VB PE SD 220** or **IDROPRIMER + POLYVAP**)
- ③ Perimeter sealing
- ④ Thermal insulation layer

- ⑤ Waterproofing membrane **MAPEPLAN T B**
- ⑥ **MAPEPLAN T** outlet
- ⑦ Welding
- ⑧ Protection layer **POLYDREN PP**
- ⑨ Leaf/gravel guard
- ⑩ Gravel

Detail S-0415 - Roof drain

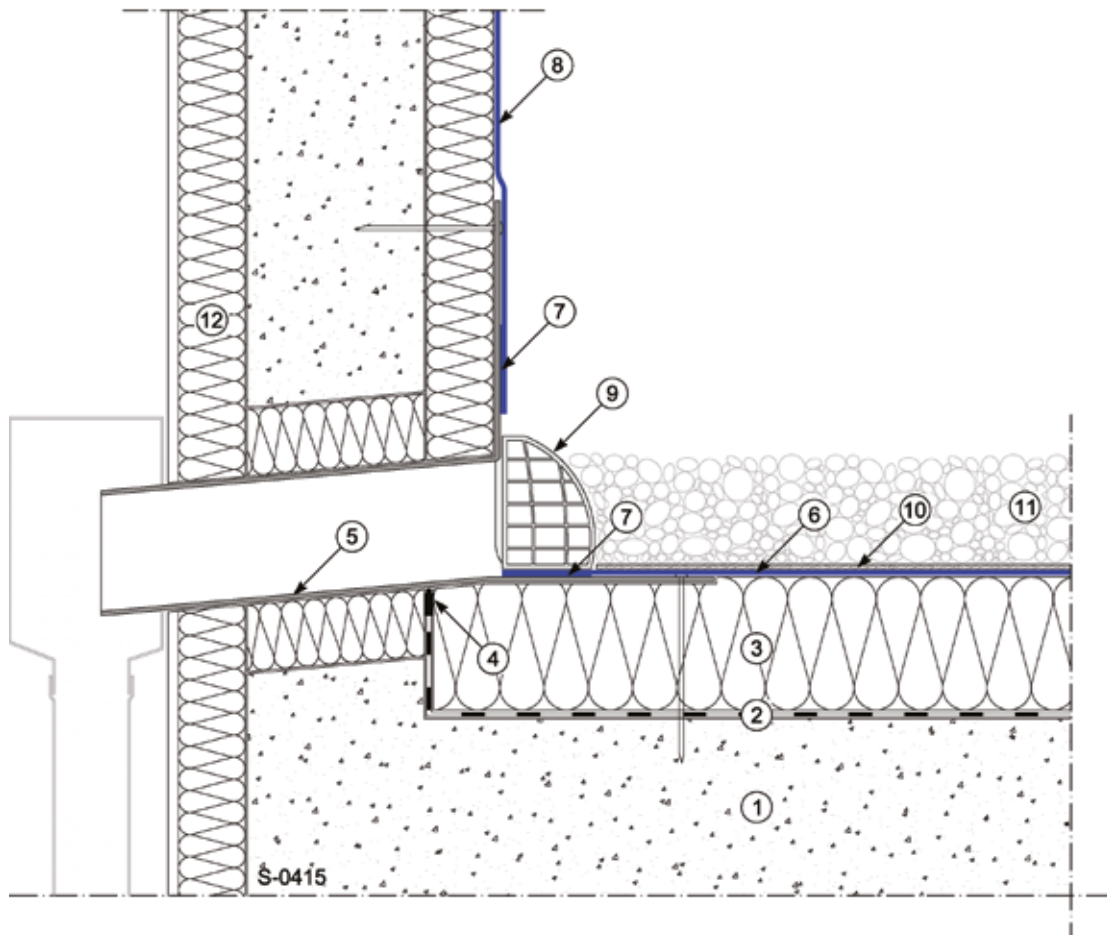

- ① Structure
- ② Vapour barrier sealed on overlaps and on perimeters
(e.g. **MAPEPLAN VB PE SD 220** or **IDROPRIMER + POLYVAP**)
- ③ Thermal insulation layer
- ④ Perimeter sealing
- ⑤ **MAPEPLAN T** wall outlet

- ⑥ Waterproofing membrane **MAPEPLAN T B**
- ⑦ Welding
- ⑧ Fully adhered **MAPEPLAN T** waterproofing membrane
- ⑨ Leaf/gravel guard
- ⑩ Protection layer **POLYDREN PP**
- ⑪ Gravel
- ⑫ Façade insulation panel

Detail S-0419 - Roof drain

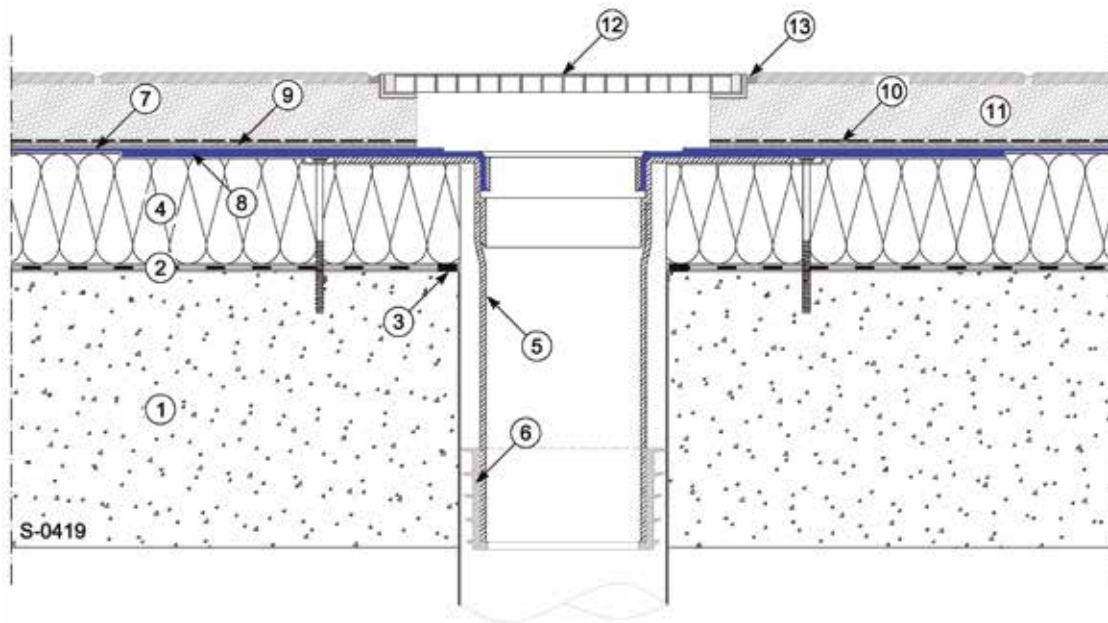

- | | |
|--|--|
| ① Structure | ⑦ Waterproofing membrane MAPEPLAN T B |
| ② Vapour barrier sealed on overlaps and on perimeters
(e.g. MAPEPLAN VB PE SD 220 or IDROPRIMER + POLYVAP) | ⑧ Welding |
| ③ Perimeter sealing | ⑨ Protection layer POLYDREN PP |
| ④ Thermal insulation layer | ⑩ MAPEPLAN PE micro-perforated separation and antisoaking layer |
| ⑤ MAPEPLAN T OUTLET PLUS | ⑪ Paving with tile flooring |
| ⑥ Anti-overflowing lamellar sealing gasket | ⑫ Frame and grid for pedestrian traffic |
| | ⑬ Elastic sealing |

Detail S-0420 - Roof drain

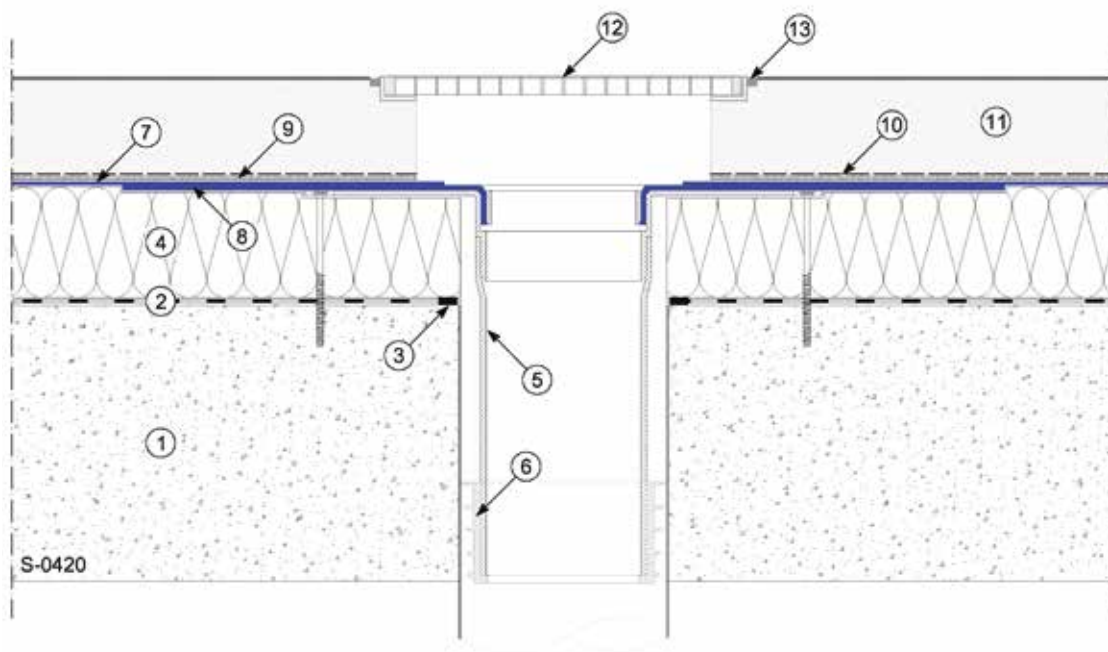

- ① Structure
- ② Vapour barrier sealed on overlaps and on perimeters (e.g. **MAPEPLAN VB PE SD 220** or **IDROPRIMER + POLYVAP**)
- ③ Perimeter sealing
- ④ Thermal insulation layer
- ⑤ **MAPEPLAN T OUTLET PLUS**
- ⑥ Anti-overflowing lamellar sealing gasket

- ⑦ Waterproofing membrane **MAPEPLAN T B**
- ⑧ Welding
- ⑨ Protection layer **POLYDREN PP**
- ⑩ **MAPEPLAN PE micro-perforated** separation and antisoaking layer
- ⑪ Concrete screed with asphalt surface course
- ⑫ Frame and grid for vehicle traffic
- ⑬ Elastic sealing

Detail S-0421 - Roof drain

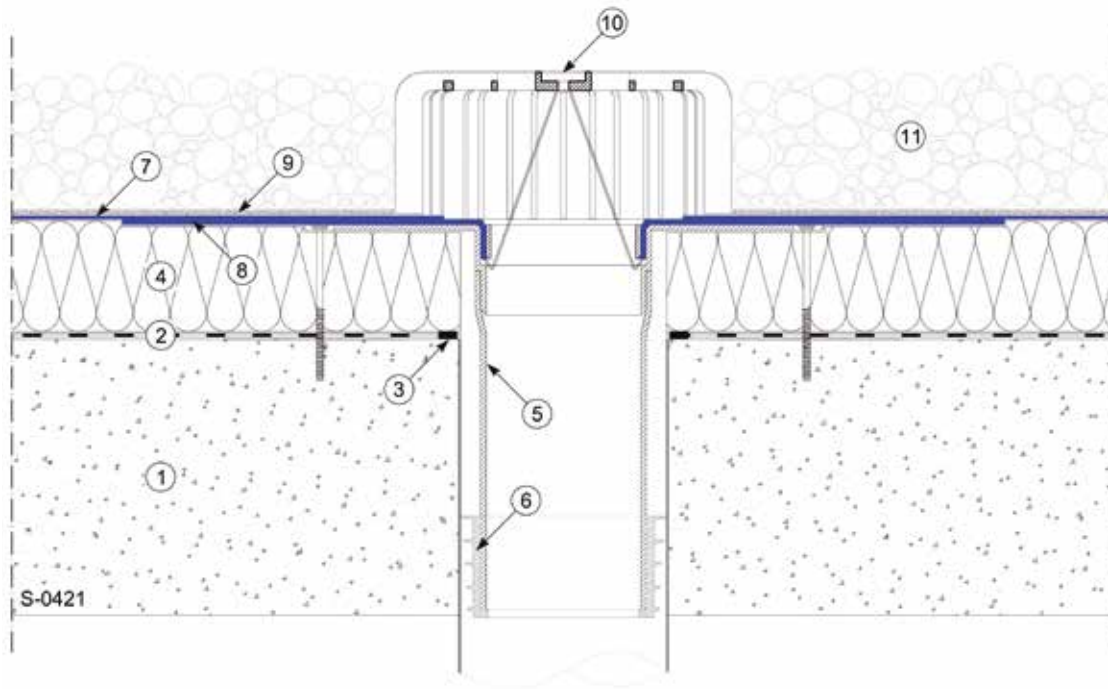

- | | |
|--|--|
| ① Structure | ⑥ Anti-overflowing lamellar sealing gasket |
| ② Vapour barrier sealed on overlaps and on perimeters
(e.g. MAPEPLAN VB PE SD 220 or IDROPRIMER + POLYVAP) | ⑦ Waterproofing membrane MAPEPLAN T B |
| ③ Perimeter sealing | ⑧ Welding |
| ④ Thermal insulation layer | ⑨ Protection layer POLYDREN PP |
| ⑤ MAPEPLAN T OUTLET PLUS | ⑩ Leaf/gravel guard |
| | ⑪ Gravel |

Detail S-0500 - Pipe connection

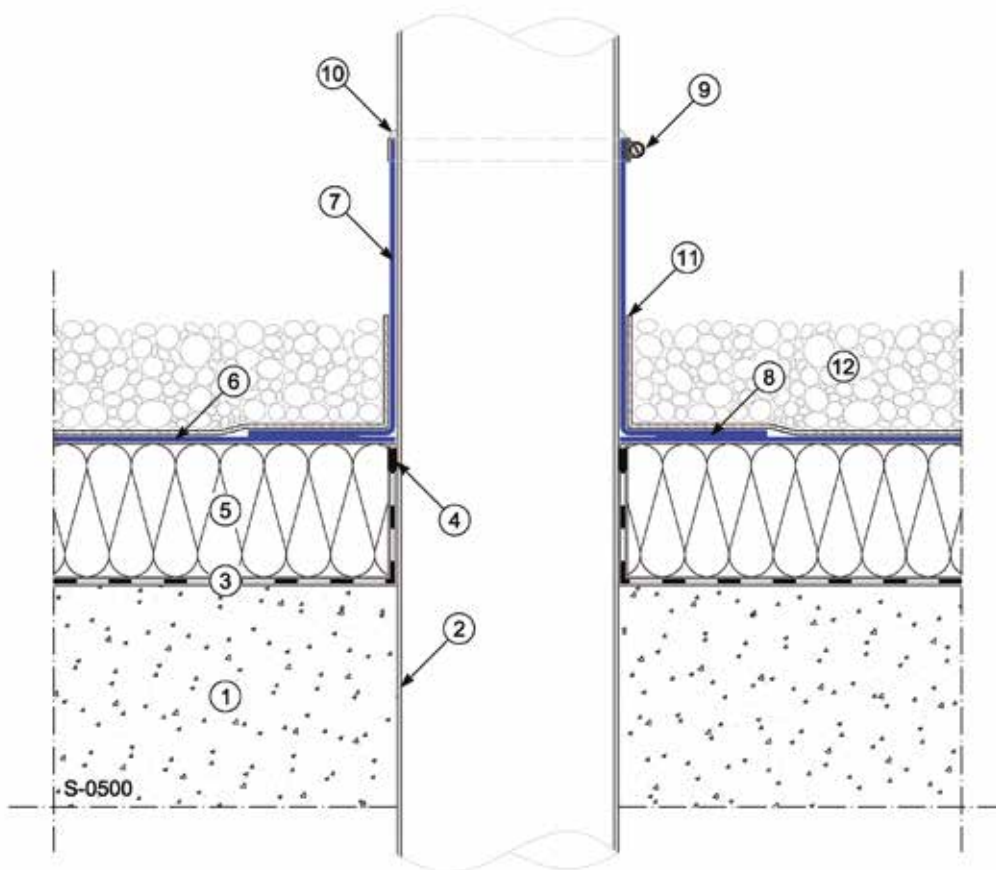

- ① Structure
- ② Pipe
- ③ Vapour barrier sealed on overlaps and on perimeters (e.g. **MAPEPLAN VB PE SD 220** or **IDROPRIMER + POLYVAP**)
- ④ Perimeter sealing
- ⑤ Thermal insulation layer

- ⑥ Waterproofing membrane **MAPEPLAN T B**
- ⑦ **MAPEPLAN T** collar
- ⑧ Welding
- ⑨ Stainless steel clamp
- ⑩ Sealing with **MAPEPLAN SEALANT KIT**
- ⑪ Protection layer **POLYDREN PP**
- ⑫ Gravel

Detail S-0503 - Fall arrest anchor fastening

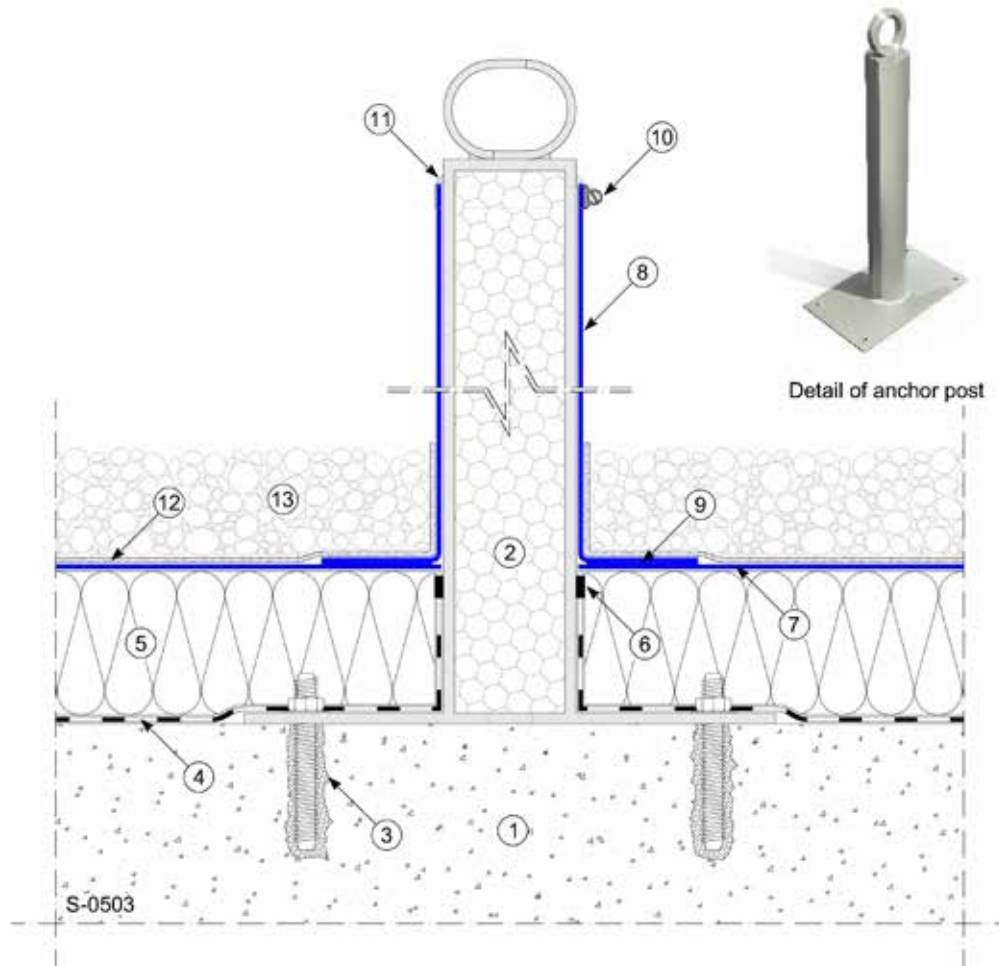

- | | |
|---|---|
| <ul style="list-style-type: none"> ① Structure ② Fall arrest anchor post ③ Fall arrest anchor fastening ④ Vapour barrier sealed on overlaps and on perimeters
(e.g. MAPEPLAN VB PE SD 220 or IDROPRIMER + POLYVAP) ⑤ Thermal insulation layer ⑥ Perimeter sealing | <ul style="list-style-type: none"> ⑦ Waterproofing membrane MAPEPLAN T B ⑧ MAPEPLAN T collar ⑨ Welding ⑩ Stainless steel clamp ⑪ Sealing with MAPEPLAN SEALANT KIT ⑫ Protection layer POLYDREN PP ⑬ Gravel |
|---|---|

Detail S-0524 - Photovoltaic panel fastening

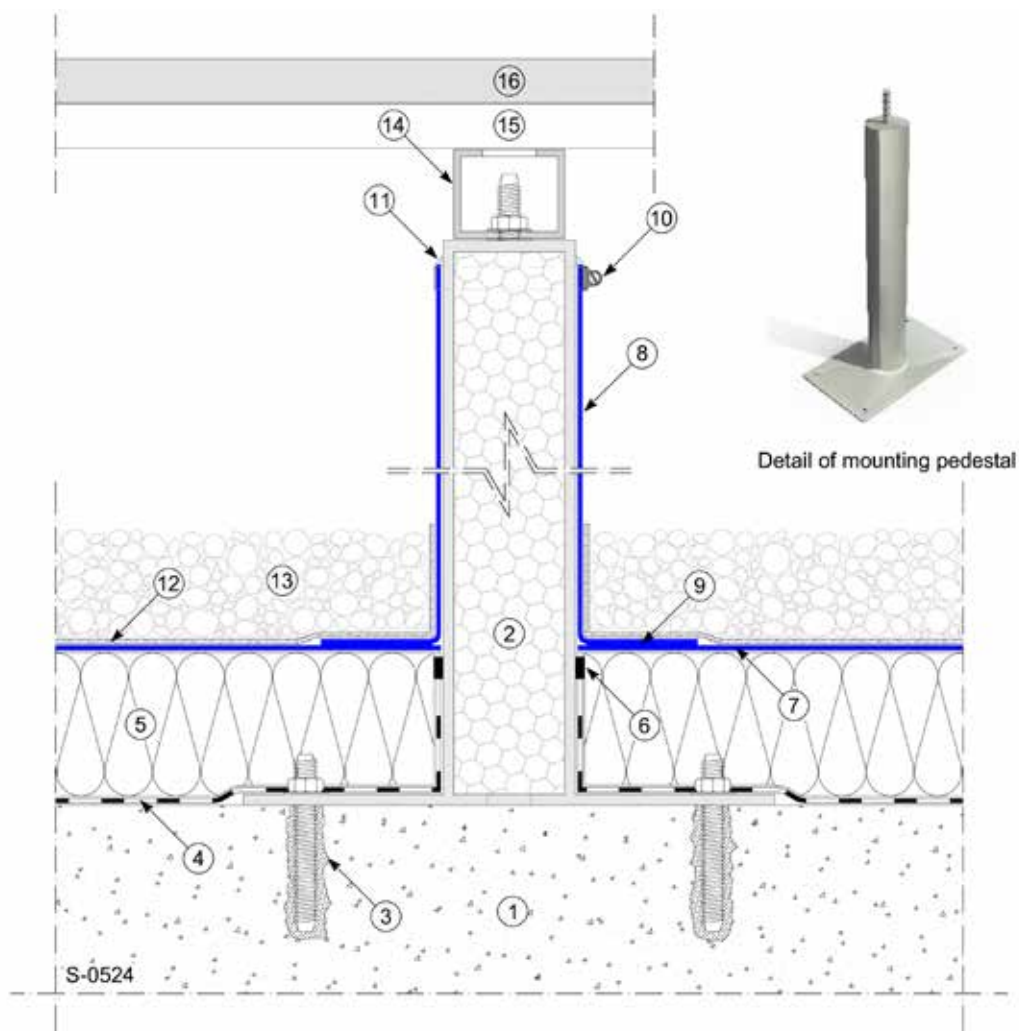

- | | |
|--|--|
| ① Structure | ⑧ MAPEPLAN T collar |
| ② Mounting pedestal | ⑨ Welding |
| ③ Mounting pedestal anchor fastening | ⑩ Stainless steel clamp |
| ④ Vapour barrier sealed on overlaps and on perimeters
(e.g. MAPEPLAN VB PE SD 220 or IDROPRIMER +
POLYVAP) | ⑪ Sealing with MAPEPLAN SEALANT KIT |
| ⑤ Thermal insulation layer | ⑫ Protection layer POLYDREN PP |
| ⑥ Perimeter sealing | ⑬ Gravel |
| ⑦ Waterproofing membrane MAPEPLAN T B | ⑭ Load-bearing tubular attachment |
| | ⑮ Photovoltaic module mounting profile |
| | ⑯ Photovoltaic module |

Detail S-0526 - Photovoltaic panel fastening

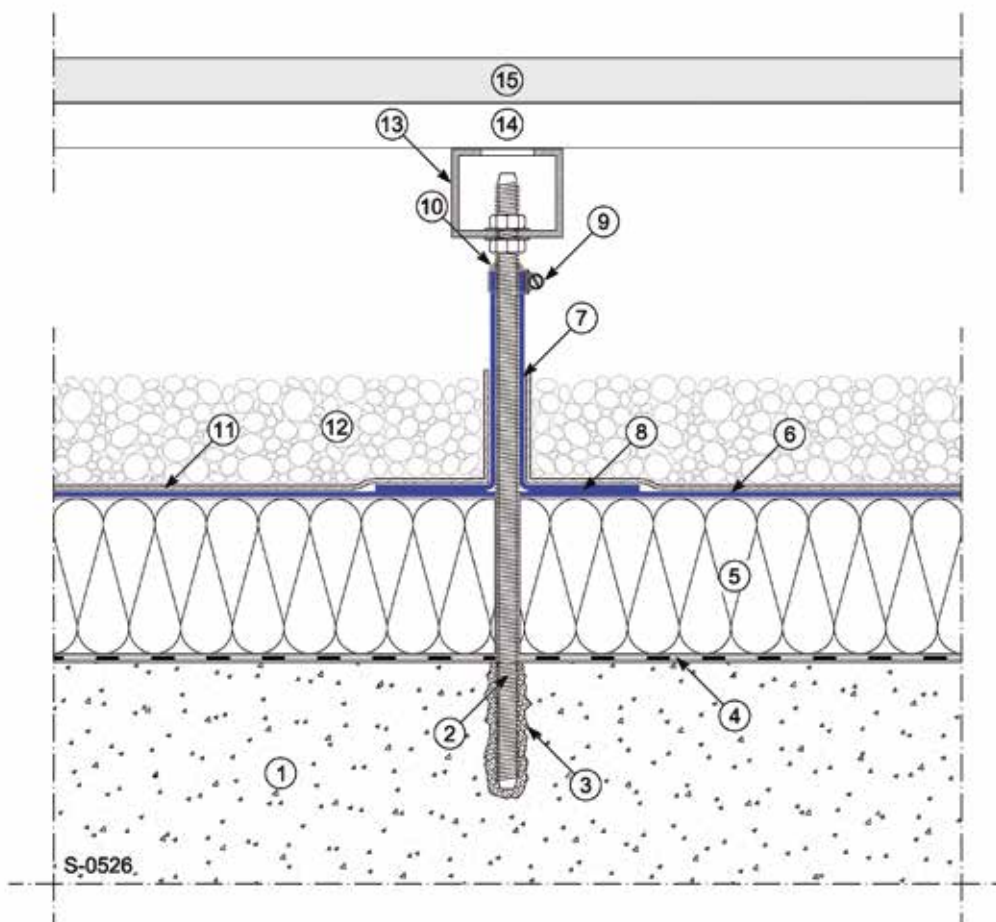

- | | |
|--|--|
| ① Structure | ⑧ Welding |
| ② Stainless steel threaded bar | ⑨ Stainless steel clamp |
| ③ Chemical anchor | ⑩ Sealing with MAPEPLAN SEALANT KIT |
| ④ Vapour barrier sealed on overlaps and on perimeters
(e.g. MAPEPLAN VB PE SD 220 or IDROPRIMER + POLYVAP) | ⑪ Protection layer POLYDREN PP |
| ⑤ Thermal insulation layer | ⑫ Gravel |
| ⑥ Waterproofing membrane MAPEPLAN T B | ⑬ Load-bearing tubular attachment |
| ⑦ MAPEPLAN T collar | ⑭ Photovoltaic module mounting profile |
| | ⑮ Photovoltaic module |

Detail S-0609 - Expansion joint

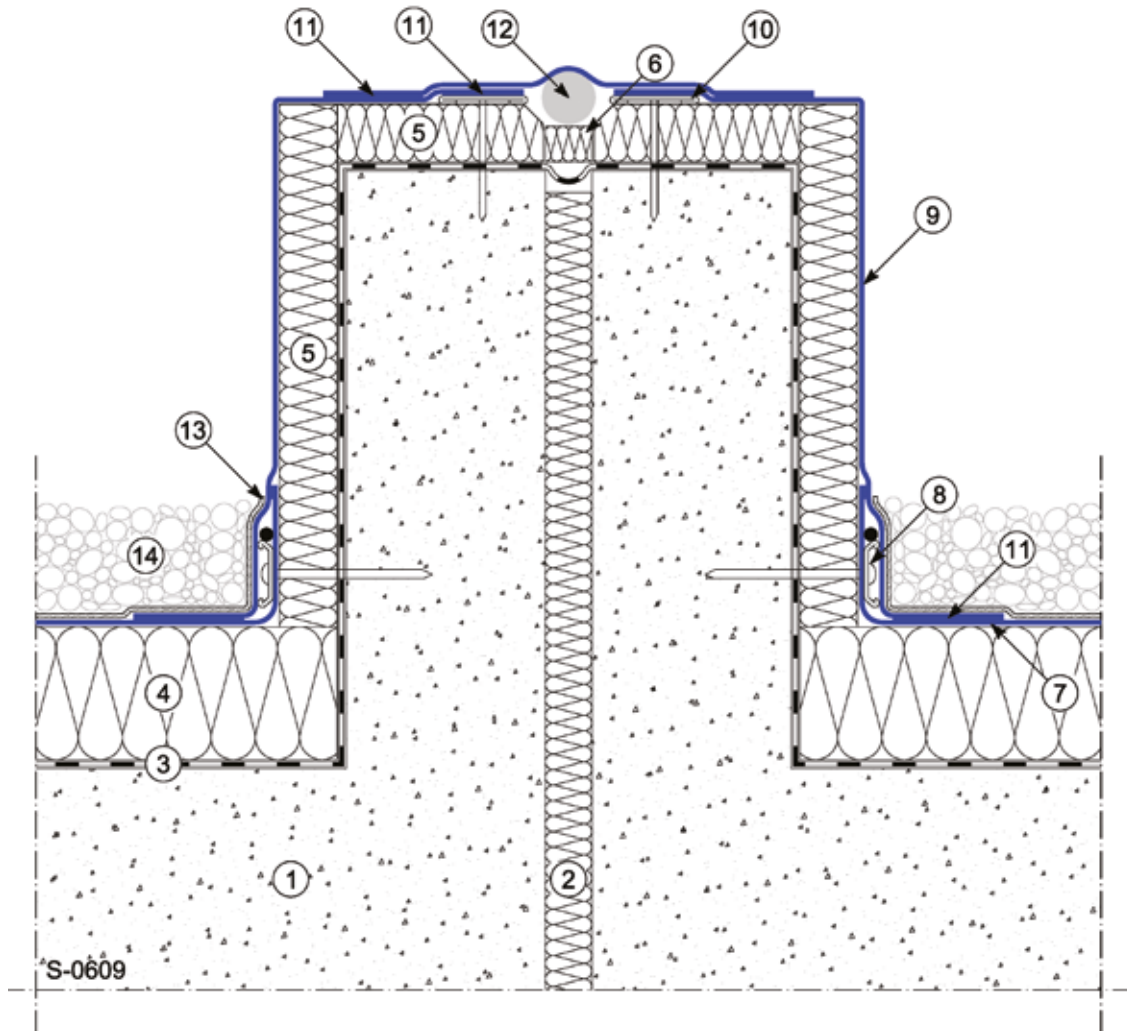

- | | |
|---|--|
| <ul style="list-style-type: none"> ① Structure ② Compressible insulation ③ Vapour barrier sealed on overlaps and on perimeters
(e.g. MAPEPLAN VB PE SD 220 or IDROPRIMER + POLYVAP) ④ Thermal insulation layer ⑤ Insulation panel PUR/PIR with glass veil ⑥ Compressible insulation ⑦ Waterproofing membrane MAPEPLAN T B | <ul style="list-style-type: none"> ⑧ Mechanical fastening MAPEPLAN METALBAR + MAPEPLAN T CORD ⑨ Fully adhered MAPEPLAN T waterproofing membrane ⑩ MAPEPLAN T strip profile ⑪ Welding ⑫ Expanded PE nosing ⑬ Protection layer POLYDREN PP ⑭ Gravel |
|---|--|

Detail S-0612 - Expansion joint

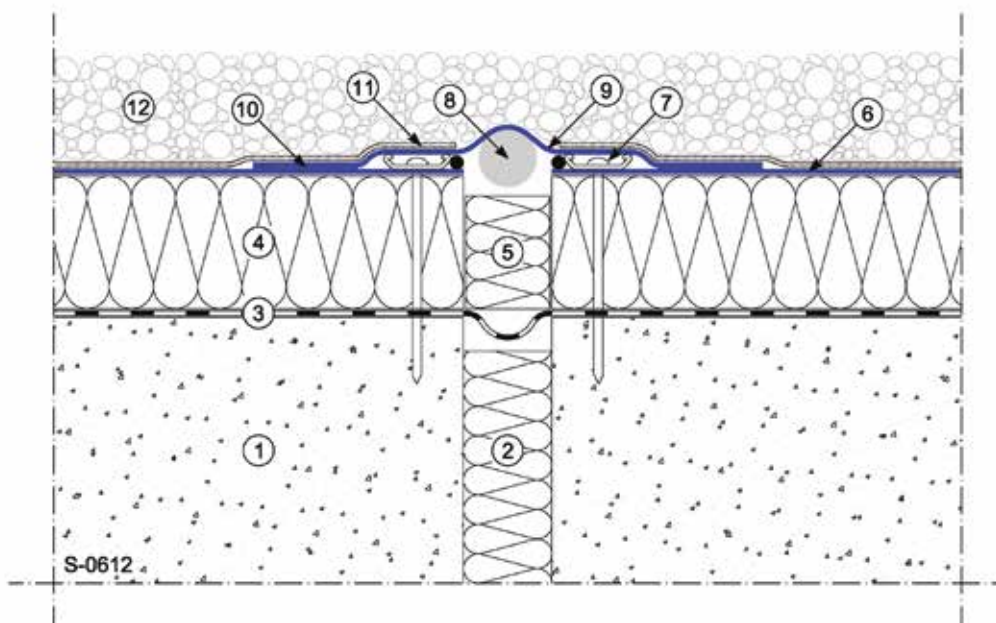

- | | |
|--|---|
| ① Structure | ⑦ Mechanical fastening MAPEPLAN METALBAR + MAPEPLAN T CORD |
| ② Compressible insulation | ⑧ Expanded PE nosing |
| ③ Vapour barrier sealed on overlaps and on perimeters
(e.g. MAPEPLAN VB PE SD 220 or IDROPRIMER + POLYVAP) | ⑨ Strip of MAPEPLAN T membrane |
| ④ Thermal insulation layer | ⑩ Welding |
| ⑤ Compressible insulation | ⑪ Protection layer POLYDREN PP |
| ⑥ Waterproofing membrane MAPEPLAN T B | ⑫ Gravel |

Detail S-0617 - Expansion joint for vehicle traffic

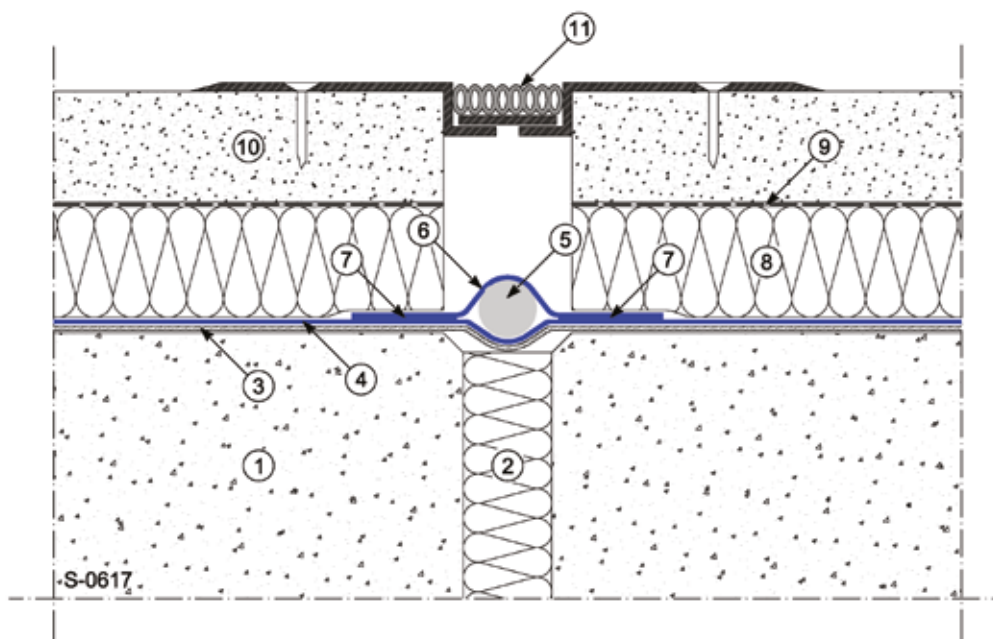

- | | |
|--|--|
| ① Structure | ⑦ Welding |
| ② Compressible insulation | ⑧ Thermal insulation layer XPS |
| ③ Levelling layer POLYDREN PP | ⑨ MAPEPLAN PE micro-perforated separation and antisoaking layer |
| ④ Waterproofing membrane MAPEPLAN T B | ⑩ Concrete screed with asphalt surface course |
| ⑤ Expanded PE nosing | ⑪ Expansion joint on floor |
| ⑥ Strip of MAPEPLAN T membrane | |

Detail S-1006 - Connection between green roof and accessible zone

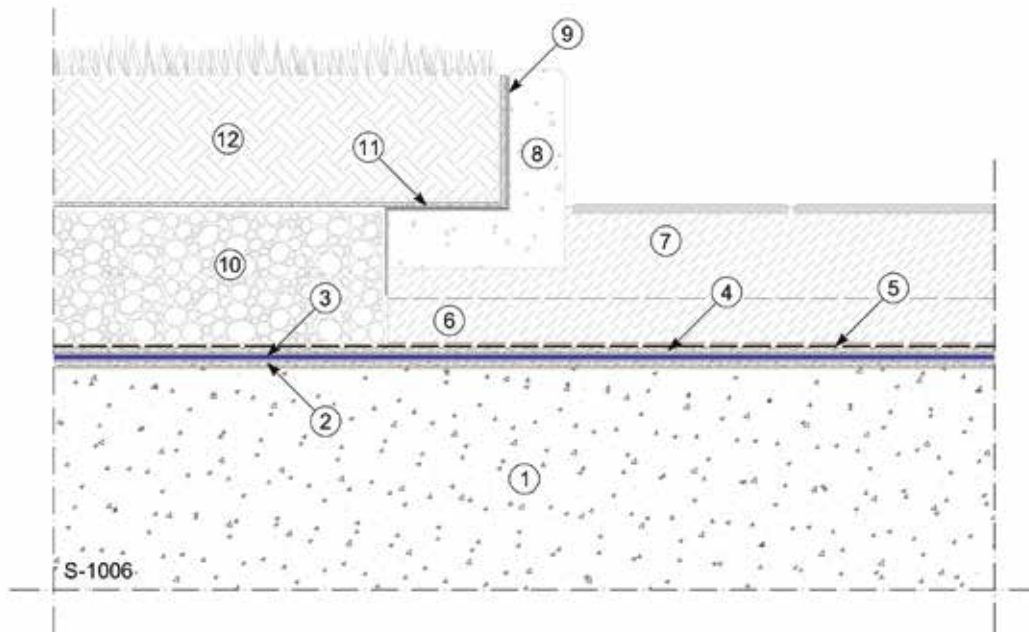

- | | |
|--|--|
| ① Structure | ⑦ Concrete screed and paving |
| ② Levelling layer POLYDREN PP | ⑧ Kerb |
| ③ Waterproofing membrane MAPEPLAN T B | ⑨ Waterproofing treatment |
| ④ Protection layer POLYDREN PP | ⑩ Drainage or drainage/water storage layer |
| ⑤ MAPEPLAN PE micro-perforated separation and antisoaking layer | ⑪ Protection layer POLYDREN PP |
| ⑥ Drainage pipe/channel (if necessary) | ⑫ Growing substrate |

RELATED TECHNICAL DOCUMENTS

The technical literature mentioned below can be accessed via the website www.polyglass.com



Technical book ROOFING SYSTEM MAPEPLAN T FPO/TPO

This document contains technical information of roofing system doable with MAPEPLAN T waterproofing membranes.

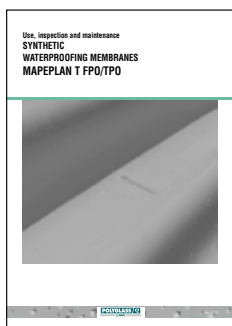

Use, inspection and maintenance SYNTHETIC WATERPROOFING MEMBRANES MAPEPLAN T FPO/TPO

This document contains more in-depth technical information on the use, inspection and maintenance of MAPEPLAN T waterproofing membranes.

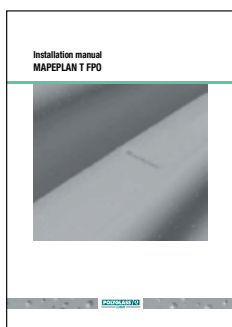

MAPEPLAN T FPO/TPO installation manual

This document contains correct, detailed instructions on installing and laying MAPEPLAN T waterproofing membranes.



Technical Book for Waterproofing Systems for GREEN ROOFS MAPEPLAN T B

This document provides technical, design and construction information and solutions for the correct installation of green roof waterproofing and thermal insulation systems, with the use of MAPEPLAN T B flexible polyolefin (FPO/TPO) synthetic waterproofing membranes.

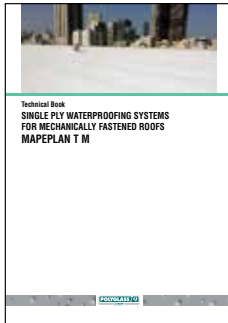

Technical book SINGLE PLY WATERPROOFING SYSTEMS FOR MECHANICALLY FASTENED ROOFS MAPEPLAN T M

This document provides technical, design and construction information and solutions for the correct installation of single ply waterproofing systems for mechanically fastened roofs, with the use of MAPEPLAN T M flexible polyolefin (FPO/TPO) synthetic waterproofing membranes.

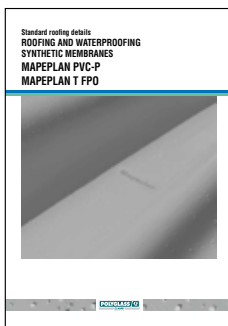

Standard roofing details ROOFING AND WATERPROOFING SYNTHETIC MEMBRANES MAPEPLAN T FPO/TPO

This document contains the collection of some standard roofing details that can be realized with MAPEPLAN T waterproofing membranes.

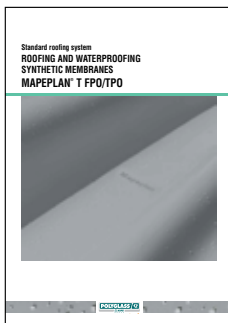

Standard roofing systems ROOFING AND WATERPROOFING SYNTHETIC MEMBRANES MAPEPLAN T FPO/TPO

This document contains the collection of some standard roofing systems that can be realized with MAPEPLAN T waterproofing membranes.

Technical Book

WATERPROOFING SYSTEM FOR BALLASTED ROOF, PEDESTRIAN ROOF AND PARKING DECK

MAPEPLAN T B

In line with our policy of continuous product development,
we reserve the right to make any required changes without prior notice.



MAPEPLAN range is produced by:



Registered Office: Viale Jenner, 4 - 20159 Milano

Head Office: Via Giorgio Squinzi, 2 - 31047 Ponte di Piave (TV) - Italia
Tel. +39 04227547 - Fax +39 0422854118 - www.polyglass.com - info@polyglass.it